

Catálogo de Productos

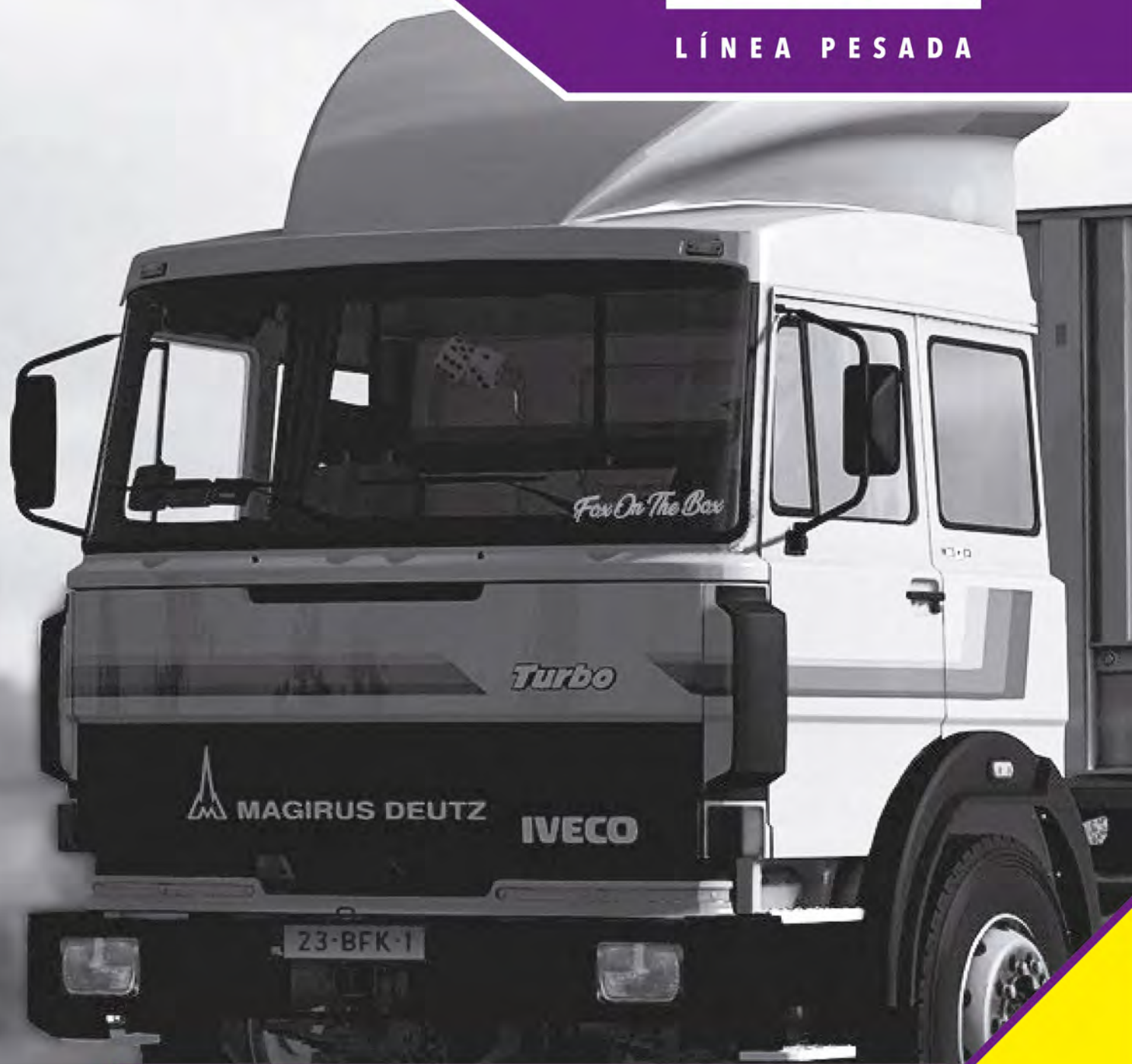

- Repuestos de inyección diesel.
- Tuberías flexibles y rígidas.
- Toberas, elementos y válvulas.





INDICE

INDICE CON LINEAS DE PRODUCTOS PARA CATÁLOGOS POR MARCAS DE VEHÍCULOS

1- Repuestos, Accesorios y Despiece para Inyección Diesel.

- Abrazaderas
- Anillos de Goma
- Arandelas
- Bombas Alimentadoras
- Bulones Perforados
- Mangueras Universales
- Cebadores
- Electroválvulas
- Filtros
- Juegos de Juntas
- Líquido aditivo Diesel Power
- Prefiltros
- Seguros para Caños de Inyección
- Uniones Orientables
- Válvulas
- Vasos

2- Tuberías Flexibles y Rígidas.

- Para Inyección
- Para Combustible
- Para Aceite
- Para Dirección Hidráulica
- Para Accionamiento de Embrague
- Para Freno Hidráulico
- Para Conducción de Agua y Aire
- Para Aire Comprimido

3- Toberas, Elementos y Válvulas "DMB".

4- Bujías Incandescentes "DMB".

5- Turbos "DMB".

6- Bombas de Combustible a Diafragma.

7- Tensores de Correas.



Guía explicativa uso de catalogo productos CMD.

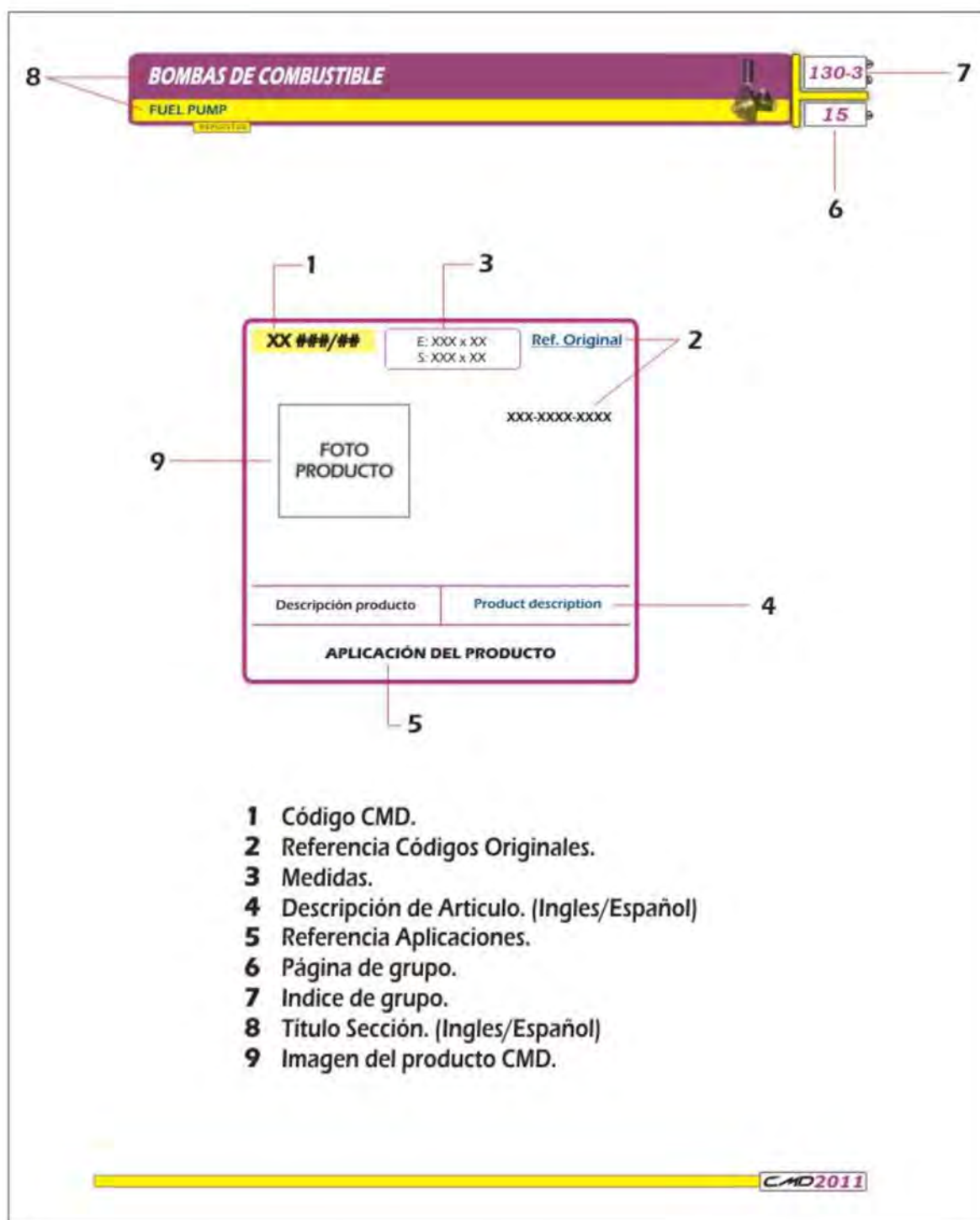

- 1 Código CMD.
- 2 Referencia Códigos Originales.
- 3 Medidas.
- 4 Descripción de Artículo. (Ingles/Español)
- 5 Referencia Aplicaciones.
- 6 Página de grupo.
- 7 Indice de grupo.
- 8 Título Sección. (Ingles/Español)
- 9 Imagen del producto CMD.

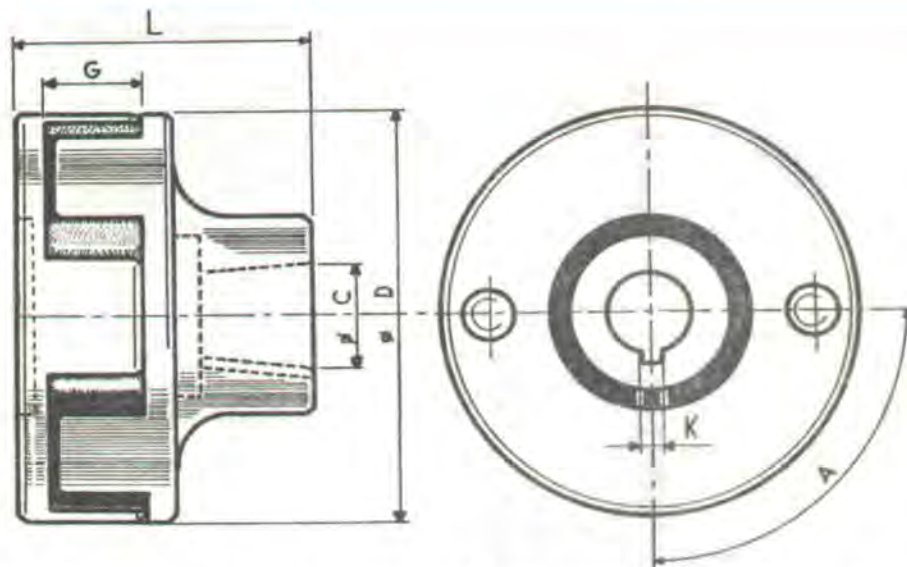

L	A	C	G	D	d	K	Cono	Cod. CMD
50	90°	16	16	74	37	3	A	AE 102-1
50	90°	19	16	74	37	4	B	AE 102-2
65	90	16	16	74	37	3	A	AE 102-3
77		16	16	74	37	3	A	AE 102-4
50	*	20	13	85		4	CIL	AE 102-5
51	90	19	17	85	37	4	B	AE 102-6
52	90°	19	23	74	37	4	B	AE 102-9
43	*	20	16	105	*	4	CIL	AE 102-10
*	*	20	20	74	*	4,7	B	AE 102-12
68	90°	19	20	90	37	4	B	AE 102-13
*	*	20	31	99	*	4,7	CIL	AE 102-14

L	A	C	G	D	d	K	Cono	Cod. CMD
80	*	21	16	85	*	*	*	AE 102-15
70		16	23	74	37	3	A	AE 102-16
44	90°	16	16	74	37	3	A	AE 102-17
50	90°	19	20	90	37	4	B	AE 102-18
*	*	*	20	74	*	4,7	CIL	AE 102-19
50	90°	19	20	90	37	4	B	AE 102-20
*	*	20	*	105	*	4	*	AE 102-21
*	*	20	*	105	*	4	CIL	AE 102-22
117		25	29	105		4,7	P	AE 102-23
118		30	29	105		4,7	P	AE 102-24

AE 102/1



Bomba tipo A

DEUTZ

AE 102/13



DEUTZ A-70

AE 102/18



DEUTZ A-85

AE 102/20



Deutz 12 puntas

DEUTZ A-85

AE 102/25



Deutz
301-2167

AE 102/27



Deutz
3012170

DEUTZ A65 / A85 / 1114 / 2114 CARDANICO

Para acople cardánico pieza con eje

DEUTZ

AE 102/28



Deutz
3012174

AE 102/29



Deutz
3012169

Para acople cardánico pieza estriada

Para acople cardánico pieza con cono

DEUTZ

DEUTZ

AE 102/30



Deutz
3012175

AE 102/31



Deutz
3012698

Para acople cardánico pieza con disco

Para acople cardánico pieza con abrazadera

DEUTZ

DEUTZ

AG 103/1



Para AE 102/1 - AE 102/2 AE 102/3 - AE 102/4

DEUTZ

AG 103/4



DEUTZ

AG 103/9



Para bomba

DEUTZ A-85

AG 103/10



De 12 puntas

DEUTZ

AG 103/13



Deutz
3012576

De Cardánico de poliuretano, roja

DEUTZ

AG 103/14



Para tipo A y D26

DEUTZ

REPUESTOS

AH 104/1



Plana

**SCANIA VABIS / CHEVROLET 350 / DEUTZ
P/NISSAN 175-205 / ISUZU 6BD1 / HINO**

AH 104/5



Arandela buje

**SCANIA VABIS / CHEVROLET 350 / DEUTZ
P/NISSAN 175-205 / ISUZU 6BD1 / HINO**

AG 105/1

6 mm



Bosch
2916699083
2916693005
2916690005
2916698053
2916699132

Arandela grower

DEUTZ

AG 105/2

8 mm



Arandela grower

DEUTZ

AG 105/3

10 mm



Arandela grower

DEUTZ

AG 105/4

1/2 "



Arandela grower

DEUTZ

AG 105/5

9/16" mm



Arandela grower

DEUTZ

AG 105/6

16 mm



Arandela grower

DEUTZ

AG 105/7

6 mm



Lucas
9007200R

Arandela grower

DEUTZ

AG 105/8

18 mm



Bosch
2916693012

Arandela grower

DEUTZ

AG 105/9

6 mm



Bosch
2916693013

Arandela grower

DEUTZ

AG 105/10

18 mm



Arandela grower

DEUTZ

AG 105/11

12 x 17 mm



Bosch
1420151001

Arandela grower de regulador RSV

DEUTZ

AG 105/12





















Bosch
2916699093

Arandela grower de 1" para bomba tipo P

DEUTZ

REPUESTOS

CÓDIGO	MEDIDA (mm)	
AL 105/1	4 x 9 x 1.25	
AL 105/2	5 x 9 x 1.25	
AL 105/2A	5 x 13 x 1.25	
AL 105/3	6 x 10 x 1.25	
AL 105/3A	7 x 10 x 1.25	
AL 105/3B	7 x 14 x 1.25	
AL 105/3C	7 x 14 x 2	
AL 105/4	8 x 13 x 1.25	
AL 105/5	8 x 12x1 (doble)	
AL 105/6	9 x 14.5 x 1.25	
AL 105/7	10 x 14.5 x 1.25	
AL 105/8	11 x 17 x 1.25	
AL 105/9	12 x 17 x 1.25	
AL 105/10	13 x 20 x 1.25	
AL 105/11	14 x 20 x 1.25	
AL 105/11A	14 x 23 x 1.25	
AL 105/12	15 x 21 x 1.25	
AL 105/13	16 x 21 x 1.25	
AL 105/13A	16 x 24 x 1.25	
AL 105/14	17 x 22 x 1.25	
AL 105/15	18 x 23 x 1.25	
AL 105/15A	19 x 23 x 1.25	
AL 105/15B	18 x 25 x 1.25	
AL 105/16	20 x 26 x 1.25	
AL 105/17	22 x 28 x 1.25	
AL 105/18	24 x 30 x 1.25	
AL 105/19	26 x 32 x 1.25	
AL 105/20	28 x 36 x 1.25	
AL 105/21	30 x 36 x 1.25	

CÓDIGO	MEDIDA (mm)	
AL 105/22	32 x 40 x 1.25	
AL 105/23	34 x 42 x 1.25	
AL 105/23A	35 x 41 x 1.25	
AL 105/24	36 x 42 x 1.25	
AL 105/25	38 x 46 x 1.25	
AL 105/25A	39.5 x 53 x 0.5	
AL 105/26	41 x 45 x 1.25	
AL 105/26A	41 x 55 x 1.25	
AL 105/26B	41 x 55 x 0.5	
AL 105/27	42 x 49 x 1.25	
AL 105/28	44 x 52 x 1.25	
AL 105/29	46 x 54 x 1.25	
AL 105/30	52 x 60 x 1.25	

REPUESTOS

CÓDIGO	MEDIDA (mm)
CO 105/1	4 x 9 x 1.25
CO 105/2	5 x 9 x 1.25
CO 105/3	6 x 10 x 1.25
CO 105/3A	6 x 10 x 1 (doble)
CO 105/3B	7 x 14 x 1.25
CO 105/4	8 x 12.5 x 1.25
CO 105/4A	8 x 11 x 1.25
CO 105/5	8 x 12 x 1 (doble)
CO 105/6	9 x 14.5 x 1.25
CO 105/7	10 x 14 x 1.25
CO 105/8	11 x 17 x 1.25
CO 105/9	12 x 17 x 1.25
CO 105/10	13 x 20 x 1.25
CO 105/11	14 x 20 x 1.25
CO 105/11A	14 x 23 x 1.25
CO 105/12	15 x 21 x 1.25
CO 105/13	16 x 21 x 1.25
CO 105/13A	16 x 24 x 1.25
CO 105/14	17 x 22 x 1.25
CO 105/15	18 x 23 x 1.25
CO 105/16	20 x 26 x 1.25
CO 105/17	22 x 26 x 1.25
CO 105/18	24 x 30 x 1.25
CO 105/19	26 x 32 x 1.25
CO 105/20	28 x 36 x 1.25
CO 105/21	30 x 36 x 1.25
CO 105/22	32 x 40 x 1.25
CO 105/23	34 x 42 x 1.25
CO 105/24	36 x 42 x 1.25

CÓDIGO	MEDIDA (mm)
CO 105/25	38 x 46 x 1.25
CO 105/26	41 x 45 x 1.25
CO 105/27	42 x 49 x 1.25
CO 105/28	44 x 52 x 1.25
CO 105/29	46 x 54 x 1.25
CO 105/30	52 x 60 x 1.25



REPUESTOS

CÓDIGO	MEDIDA (mm)
FI 105/2	5 x 9 x 1.5
FI 105/2A	5 x 12 x 1.5
FI 105/3	6 x 10 x 1.5
FI 105/3A	6.5 x 12.5 x 1.5
FI 105/4	8 x 13 x 1.5
FI 105/6	9 x 14.5 x 1.5
FI 105/7	10 x 14 x 1.5
FI 105/8	11 x 17 x 1.5
FI 105/9	12 x 17 x 1.5
FI 105/10	13 x 20 x 1.5
FI 105/10A	13 x 24 x 1.5
FI 105/11	14 x 20 x 1.5
FI 105/12	15 x 21 x 1.5
FI 105/13	16 x 21 x 1.5
FI 105/13A	16 x 24 x 1.5
FI 105/14	17 x 22 x 1.5
FI 105/15	18 x 23 x 1.5
FI 105/16	20 x 26 x 1.5
FI 105/17	22 x 28 x 1.5
FI 105/18	24 x 30 x 1.5
FI 105/19	26 x 32 x 1.5
FI 105/20	28 x 36 x 1.5
FI 105/21	30 x 36 x 1.5
FI 105/22	32 x 40 x 1.5
FI 105/23	34 x 42 x 1.5
FI 105/24	36 x 42 x 1.5
FI 105/25	38 x 46 x 1.5
FI 105/26	41 x 45 x 1.5
FI 105/27	42 x 49 x 1.5

CÓDIGO	MEDIDA (mm)
FI 105/28	44 x 52 x 1.5
FI 105/29	46 x 54 x 1.5
FI 105/30	52 x 60 x 1.5



AC 112/64

7.2 x 12,85 x 1.5



Arandela de asiento de inyector de cobre

DEUTZ 1011/1013

AV 114/16

9.5 x 14.5 mm



Arandela de cobre inyección directa superior con pestaña

DEUTZ / M. BENZ 1114

AV 114/22

9.75 x 12,75 x 0.5 mm



Arandela de bronce plana

DEUTZ / M. BENZ 1114

REPUESTOS

AV 116/7



Arandela de cobre cónica para caño de inyección de 6 x 10

DEUTZ

REPUESTOS

	Pulgadas		Milímetros	
	Ø min	Ø max	Ø min	Ø max
AB 117/1	5/16	3/8	8	10
AB 117/1A	De 8 a 12 con cremallera			
AB 117/2	3/8	1/2	10	12
AB 117/2A	7/16	17/32	11	11.5
AB 117/3	1/2	9/16	12	14
AB 117/4	9/16	5/8	14	16.5
AB 117/4A	De 10 a 16 con cremallera			
AB 117/5	11/16	3/4	17	19.5

Fleje ancho 9 mm - Espesor 0.5 mm

COMPACTA

	Pulgadas		Milímetros	
	Ø min	Ø max	Ø min	Ø max
AB 117/6	5/16	5/8	8	16
AB 117/7	3/8	13/16	10	20
AB 117/7A	1/2	1	12	26
AB 117/8	3/4	1 1/4	20	32
AB 117/9	1 1/4	1 3/4	30	45
AB 117/10	1 9/16	2 1/8	40	55
AB 117/11	2	2 9/16	50	65
AB 117/12	2 3/8	3	60	75

Fleje ancho 8.5 mm - Espesor 0.8 mm

MINI SUPER

	Pulgadas		Milímetros	
	Ø min	Ø max	Ø min	Ø max
AB 117/13	2 3/4	3 3/8	70	85
AB 117/14	3 1/8	3 3/4	80	95
AB 117/15	3 1/2	4 1/8	90	105
AB 117/16	3 5/16	4 1/2	100	115
AB 117/17	4 5/16	4 15/16	110	125
AB 117/18	5 1/8	5 11/16	130	145

	Pulgadas		Milímetros	
	Ø min	Ø max	Ø min	Ø max
AB 117/19	1 3/8	1 3/4	35	45
AB 117/20	1 9/16	2 1/8	40	55
AB 117/21	1 3/4	2 3/8	45	60
AB 117/22	2 3/8	3	60	75
AB 117/23	2 3/4	3 3/8	70	85
AB 117/24	3 1/8	3 3/4	80	95
AB 117/25	3 1/2	4 1/4	90	105
AB 117/26	3 3/8	4 1/2	100	115

Fleje ancho 14.4 mm - Espesor 0.8 mm

SUPER CIERRE RAPIDO

	Pulgadas		Milímetros	
	Ø min	Ø max	Ø min	Ø max
AB 117/29	9/16	3/4	14	20
AB 117/30	5/8	7/8	16	22
AB 117/31	3/4	1 1/8	20	28
AB 117/32	1	1 3/8	25	35
AB 117/33	1 3/16	1 9/16	30	40
AB 117/34	1 3/8	1 3/4	35	45
AB 117/34A	1 1/2	2	38	50
AB 117/35	1 9/16	2 1/8	40	55
AB 117/36	1 3/4	2 3/8	45	60

Fleje ancho 14.4 mm - Espesor 0.8 mm

TIPO AMERICANA

	Pulgadas		Milímetros	
	Ø min	Ø max	Ø min	Ø max
AB 117/37	2	2 5/8	50	65
AB 117/38	2 3/8	3	60	75
AB 117/39	2 3/4	3 3/8	70	85
AB 117/40	3 1/8	3 3/4	80	95
AB 117/41	3 1/2	4 1/8	90	105
AB 117/42	3 15/16	4 1/5	100	115
AB 117/43	4 5/16	4 15/16	110	125
AB 117/44	5 1/8	5 11/16	130	145

REPUESTOS

	Pulgadas		Milímetros	
	Ø min	Ø max	Ø min	Ø max
AB 117/90	1/4	5/8	6	16
AB 117/91	7/16	13/16	11	20
AB 117/92	1/2	15/16	13	24



Fleje ancho 8 mm - Espesor 0.5 mm

REPUESTOS

PLASTIC CLIPS

	Pulgadas	
	Ø min	Ø max
AB 117/45	9	11
AB 117/46	11	13
AB 117/47	13	15
AB 117/48	15	17
AB 117/49	17	19
AB 117/50	19	21
AB 117/51	21	23
AB 117/52	23	25
AB 117/53	25	27
AB 117/54	27	29
AB 117/55	29	31
AB 117/56	31	33
AB 117/57	33	35
AB 117/58	35	37
AB 117/59	37	41
AB 117/60	41	44
AB 117/61	44	47
AB 117/62	47	50
AB 117/63	50	54
AB 117/64	54	58
AB 117/65	58	62
AB 117/66	62	66



**SOPORTAN ALTAS PRESIONES, REUTILIZABLES, CIERRE PERFECTO.
SOPORTAN ALTAS TEMPERATURAS, ANTICORROSIVAS, ATÓXICAS.
ECONOMÍA DE COSTO, FACILIDAD DE COLOCACIÓN.**

PI 161/101



Para abrazaderas plásticas

VS

REPUESTOS

AG 122/305



O' ring para inyector

DEUTZ 1114/2114

AG 122/306



O' ring para inyector

DEUTZ 413/913

BP 129/1

8 x 1 x 17 mm



Bosch
2911235700
2433456035
Lucas / Delphi
7169-60
Deutz
300-1744
111-9231
992-8367

Para descarga de inyector

DEUTZ

BP 129/6

8 x 1 mm



Deutz
121-6492

Doble, para unión descarga

DEUTZ

BP 129/9

10 x 1 mm



Bosch
2 911 201 701

Varias aplicaciones

DEUTZ

BP 129/16

14 x 1.5 mm



Bosch
2 911 201 703
Fiat
705737
Deutz
111-9243

Varias aplicaciones

DEUTZ

BP 129/17

14 x 1.5 mm



Deutz
121-6493
Iveco
1570211

Varias aplicaciones

DEUTZ

BP 129/18

14 mm



Bosch
2 443 456 018
Zexel
152300-0920

Para filtro interior (sin filtro)

DEUTZ

BP 129/18A

14 x 1,5 mm



Bosch
2 443 456 018
Zexel
152300-0920

Para filtro interior

DEUTZ

BP 129/19

14 mm



Bosch
2 911 205 703
Fiat
763 153

Para prefiltro

DEUTZ

BP 129/20

16 x 1.5 mm



Bosch
2 911 201 705

Aplicaciones varias

DEUTZ

BP 129/21

18 mm



Fiat
746 991

Aplicaciones varias

DEUTZ

BP 129/22

20 mm



Aplicaciones varias

DEUTZ

BP 129/23

22 x 1.5



Aplicaciones varias

DEUTZ

BP 129/24

24mm



Aplicaciones varias

DEUTZ

BP 129/30

0.55



Bosch
1 463 456 303

"Bulon Out" - Valvula retorno bomba EP/VE

DEUTZ

BP 129/31

0.75



Bosch
1 463 456 344

"Bulon Out" - Válvula retorno bomba EP/VE

DEUTZ

BA 130/11**Bosch**
0 440 011 007

Bombita de llenado de circuito

DEUTZ**BA 130/11A**

Bombita de llenado de circuito

DEUTZ**BA 130/11H****Bosch**
0 440 011 010

Bombita de llenado de circuito con cebador de hierro y resorte

DEUTZ**BA 130/12****Bosch**
0 440 011 011

Bombita de llenado de circuito con pre-filtro

DEUTZ**BA 130/13****Iveco**
42023436

Bombita de llenado de circuito con prolongador CD 139/19

DEUTZ**BA 130/14****Bosch**
0 440 011 002

Bombita de llenado de circuito c/raccord RAC 173/32

DEUTZ OMNIBUS FP / AH 3/2

BA 130/17



Deutz
2111961

Bombita de llenado de circuito

DEUTZ

BA 130/21

Bosch

 0 440 003 247
 0 440 003 240
 0 440 003 998
 0 440 003 996

 FP/KE 22 AD310
 FP/KEG 22 AD112/2
 FP/KEG 22 AD283/2

KHD

 128 8172
 128 7474

 Bombita alimentadora con
 cuerpo de fundición

KHD / DEUTZ
BA 130/22

Bosch

 0 440 003 176
 9 440 030 002
 0 440 003 182
 0 440 003 184
 0 440 003 223
 0 440 003 228
 0 440 003 186
 0 440 003 183
 0 440 003 213
 0 440 003 232
 0 440 003 199
 0 440 003 212
 0 440 003 233

 FP/KE 22 AD 112/2
 FP/KE 22 AD 112/2
 FP/KE 22 AD 190/2
 FP/KE 22 AD 246/2
 FP/KE 22 AD 283/2
 FP/KE 22 AD 290
 FP/KE 22 AD 254/2
 FP/KE 22 AD 243/2
 FP/KE 22 AD 266/2
 FP/KE 22 AD 299
 FP/KE 22 AD 249/2
 FP/KE 22 AD 265/2
 FP/KE 22 AD 301/2

KHD

 128 7474
 998 1541
 1215 2606

 Bombita alimentadora con
 cuerpo de fundición

KHD / DEUTZ
BA 130/23

Bosch

 0 440 003 177
 0 440 003 185
 0 440 003 190
 9 440 030 001
 0 440 003 178
 0 440 003 180

 FP/KE 22 AD 240/2
 FP/KE 22 AD 247/2
 FP/KE 22 AD 223/2
 FP/KE 22 AD 218/2
 FP/KE 22 AD 241/2
 FP/KE 22 AD 198/2

KHD Deutz

 0128 7476
 0128 7480
 0152 17 213 10
 0152 17 213 20
 0336 6125
 336 6126
 812 2111
 0126 0836

 Bombita alimentadora p/
 bomba T/A sin filtro

KHD / DEUTZ

BA 130/29

Bosch
 0 440 004 018 - FP/KS 22 AD6
 0 440 004 017 - FP/KS 22 AD5
 0 440 030 003 - FP/KS 22 AD45/2
 0 440 004 019 - FP/KS 22 AD6/3
 0 440 004 020 - FP/KS 22 AD6/4
 0 440 004 027 - FP/KS 22 Ad15
 0 440 004 028 - FP/KS 22 AD16
 0 440 004 032 - FP/KS 22 AD15/3
 0 440 004 033 - FP/KS 22 AD15/4
 0 440 004 043 - FP/KS 22 AD6/2

Fiat	Mercedes Benz
9928977-760428	000918401
8122184-1287489	0000918301
9959826	0010910401
	0000910001
Renault	0000918501
0003020501	0010911201
0024571084	
	Man
MWM Diesel	51121017009
60520200021	KHD
	8122184
Volvo	12152597
241380 P3/P4	1287485/1287489

Bomba de combustible con cuerpo de fundición. Sin prefiltro.
 Con émbolo

DEUTZ 913
BA 130/29A

Bosch
 0 440 080 005
 0 440 004 065

Bombita alimentadora con cuerpo de fundición con filtro

DEUTZ 413/913/2114 (C/PREFILTRO)
BA 130/36

Bosch
 0 440 001 006
 0 440 001 007
 0 440 001 022
KHD
 1287462 - 8122245
 1287463

FP/K22 P5
 FP/K22 P5

FP/K 22 BC 47
 FP/K 22 BC 47/2
 FP/K 22 BC 135

Bombita alimentadora para bomba T/B sin filtro

KHD - DEUTZ
BA 130/36P

M14 X 1.5



Bosch
 0 440 004 040 - FP/K 22 BC48
 0 440 001 037 - FP/K 22 BC 161
 0 440 001 038 - FP/K 22 BC175
 0 440 001 074 - FP/K 22 BC 236/2

Magirus Deutz
 812 2185
 001 091 26 01
 352 070 0503

KHD/Deutz
 01287466
 01298719
 01301806

Bomba alimentadora para bomba T/B con pre-filtro

KHD - DEUTZ
BA 130/38

Bosch
 0 440 003 238
 0 440 003 245
 0 440 003 239
Magirus Deutz
 93190254
 FP/KEG 22AD 240/2
 FP/KEG 22AD 198/2
 FP/KEG 22AD 241/2

Bomba alimentadora

DEUTZ / KHD / MAGIRUS DEUTZ
BA 130/44

Bosch
 0 440 030 030
 0 440 004 072
 0 440 004 074
FP/KSG 22 AD 45/2

Bomba alimentadora con perno

DEUTZ

BA 130/45



Bosch
0 440 004 071
0 440 004 996
KHD / Deutz
3353174
Magirus Deutz
93190098

Bomba alimentadora con perno

DEUTZ / KHD / MAGIRUS DEUTZ

BA 130/46



Bosch
0 440 008 076
Deutz
4184575
Magirus Deutz
93160462
FP/KG 24 P 202

Bombita alimentadora

KHD / MAGIRUS DEUTZ

BA 130/53MX



Bosch
0 440 017 996 (MX)
0 440 017 011
0 440 017 003
0 440 017 021
Mercedes Benz
000902250
0020916101
Magirus Deutz
93163579
Iveco
93163579
Fiat Iveco
42484481
79046324
9959385

Bomba alimentadora

DEUTZ / MAGIRUS DEUTZ

BA 130/54V

M14x1.5



Bosch
0 440 008 008
0 440 008 077
0 440 008 090
0 440 008 114
0 440 008 116
FP/KD 22 P80 - 80I
P89 - P90 - P10 - P85

Bomba alimentadora de cuatro válvulas

KHD / DEUTZ

BA 130/55V



Bosch
0 440 008 015
0 440 008 009
Scania
21005
Iveco
319789
7681171
Mercedes Benz
0010916701
FP/K 22 P 17
FP/K 22 P 11

Bomba alimentadora

MAGIRUS DEUTZ

BA 130/56V



Bosch
0 440 008 005
0 440 008 028
0 440 008 031
0 440 008 039
0 440 008 053
0 440 008 118
0 440 008 996
FP/KD 22 P30 - P33
P41 - P59 - P91 -
P8 - P32

Flexible de refrigeración de compresor

DEUTZ

BA 130/59



Bosch
0 440 004 019
KHD/Deutz
8122184
FP/KS 22 AD 6/3

Bomba alimentadora

MAGIRUS DEUTZ

BA 130/86



Bomba alimentadora

DEUTZ 912

BA 130/201

Deutz
2112673
2113800
04503573

Bomba de combustible a polea centrifuga

DEUTZ - PUMA / BF6M1013

BA 130/213

Bosch
0440020095
0440020096
0440020121
FP/ZP18/L15*240+12/500
DCEC
D5305811
Iveco
42559145

Bomba de combustible

DEUTZ Mt12 / ISBe4 3.9 / ISBe6 5.9

BA 130/213A

Bosch
0440020096
FP/ZP18/L15*240+12/500
DCEC
D5305811

Bomba de combustible

**AGRALE-DEUTZ MT12
MOTORES ISBE4 3.9/ISBE6 5.9**

BA 130/214

Deutz
4296790
4294708
4290599
4294711

Bomba de combustible a polea centrifuga

DEUTZ BF6M2013

0222-0913

Ø M 14 x 1.5

**Deutz**
2239550
4230566
4231021
4150197
2100087
4157603
2134511
4167698
BCD
1662/7

Bomba de combustible diesel

DEUTZ 913**0222-1100**

Ø M 14 x 1.5

**Deutz**
4519 3100
BCD
2625

Bomba de combustible diesel

SAME DEUTZ - FAHR GROUP INDUSTRIAL**0222-1011****Deutz**
4175474
4175057
4174388
BCD
2682

Bomba de combustible diesel

DEUTZ B / FI1011 / E**0222-2011****Deutz**
4272819
4272616
4179734
4271682

Bomba de combustible diesel

DEUTZ F2L101 1F / 2011

CM 133/1**Bosch**
2 447 222 000

Cebador de mano corto

DEUTZ**CM 133/1AL****Bosch**
2 447 222 000
Mercedes Benz
000911101

Cebador de mano corto

DEUTZ**CM 133/1R****Bosch**
2 447 222 000
NP
155200-1120

Cebador de mano corto con resorte

DEUTZ**CM 133/2****Bosch**
2 447 222 001

Cebador de mano largo

DEUTZ**CM 133/2R****Bosch**
2 447 222 001
NP
155200-1120

Cebador de mano largo con resorte

DEUTZ**CM 133/3****Bosch**
2 447 222 001

Cebador de mano inclinado

DEUTZ**CM 133/7****Bosch**
2 447 222 125

Cebador de mano capuchón. Modelo nuevo

DEUTZ**CM 133/9**

Cebador de mano para filtro trampa de agua inclinado a 90°

DEUTZ

REPUESTOS

1

CF 138/1	5 x 9 mm
CF 138/2	8 x 12 mm
CF 138/3	9,5 x 14 mm
CF 138/7	6 x 10 mm
CF 138/8	13 x 18 mm
CF 138/9	16 x 24 mm

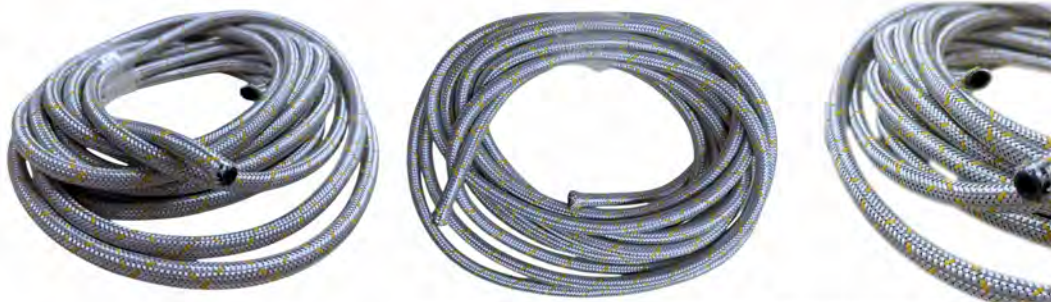
En rollo de 10 metros

REPUESTOS

1

CC 138/20	3 x 6 mm
CC 138/22	4 x 7 mm
CC 138/23	4 x 8 mm
CC 138/24	6 x 10 mm
CC 138/25	6 x 11 mm
CC 138/26	6 x 12 mm
CC 138/27	7 x 12 mm
CC 138/28	7 x 14 mm
CC 138/29	8 x 12 mm
CC 138/30	8 x 14 mm
CC 138/31	9 x 16 mm

En rollo de 50 metros

REPUESTOS

1

CH 138/35	3 x 6 mm
CH 138/36	4 x 7 mm
CH 138/37	4 x 8 mm
CH 138/38	6 x 10 mm
CH 138/39	6 x 12 mm
CH 138/40	7 x 11 mm
CH 138/41	7 x 12 mm
CH 138/42	7 x 14 mm
CH 138/43	8 x 14 mm
CH 138/44	9 x 6 mm

En rollo de 50 metros

REPUESTOS

CP 138/50	4 x 6 mm	Retorno de combustible
CP 138/51	6 x 8 mm	Lubricación de aceite
CP 138/52	7 x 10 mm	Combustible
CP 138/53	8 x 11 mm	Aire y Combustible
CP 138/54	9 x 12 mm	Aire
CP 138/54A	11 x 14 mm	Aire
CP 138/55	12 x 16 mm	
CP 138/55B	14 x 18 mm	
CP 138/56	Ø Int 1/4"	
CP 138/57	Ø Int 3/8"	
CP 138/58	Ø Int 1/2"	
CP 138/59	Ø Int 5/8"	



En rollo de 50 metros

REPUESTOS

CT 138/63	3 x 7 mm
CT 138/64	4 x 8 mm
CT 138/65	5 x 9,5 mm
CT 138/66	6 x 12 mm
CT 138/67	7 x 12 mm
CT 138/68	8 x 13 mm
CT 138/69	9 x 15 mm

En rollo de 50 metros

En rollo de 25 metros



REPUESTOS

CG 138/70	3 x 7 mm
CG 138/70A	4 x 8 mm
CG 138/70B	5,5 x 9 mm
CG 138/70C	6 x 12 mm
CG 138/70D	8 x 13 mm



En rollo de 50 metros

CD 139/6



Descarga bba. alimentadora curvo con goma

DEUTZ

CD 139/7



Descarga bba. alimentadora curvo sin goma

DEUTZ

CD 139/8



Descarga bba. alimentadora recto

DEUTZ

CD 139/13



Racord para manguera de 6 mm

DEUTZ

CD 139/15



Para descarga de inyector

DEUTZ 514

CD 139/19

Macho: M14X1.5
Hembra: M14x1.5**ADAPTADOR**

Prolongador para bomba de llenado de circuito universal

MERCEDES BENZ - DEUTZ - SCANIA

CD 139/19A

Macho: M20x1,5
Hembra: M14x1,5

Conexión prolongador para bomba auxiliar (de llenado de circuito)

MERCEDES BENZ - DEUTZ - SCANIA

REPUESTOS

CI 140/113



Bosch

0431 212 029

Cuerpo de inyector completo sin tobera

DEUTZ

EA 145/2

R= 6 X 1 mm



Extremo de acelerador tipo B

DEUTZ

EA 145/3



Extremo de acelerador

DEUTZ

EA 145/5

R= M8 x 1.25 mm



Mercedes Benz
326 991 00 22

Extremo de acelerador

DEUTZ

REPUESTOS

EF 150/52



Lucas/Delphi
7111-296

Tacita tipo Perkins - ac703

DEUTZ

EF 150/52D



Lucas/Delphi
7111-296

Tacita tipo Perkins - ac703

DEUTZ

EF 150/53



Perkins
004002

Tacita tipo Perkins boca grande - ac707

DEUTZ

EF 150/54A



Bosch
9451037406
F026402012
Mercedes Benz
A0004773515
Mann
P811

Elemento filtrante tipo Bosch 1 litro

DEUTZ

REPUESTOS

FC 151/20

Filtro trampa de agua universal

UNIVERSAL**FC 151/24****Deutz**
30241151° etapa: Trampa de agua
2° etapa: Elemento filtrante

Filtro de combustible dual

DEUTZ BF 6L 913**FC 151/25****Simil**
Deutz
30209841° etapa: Trampa de agua con malla
filtrante / 2° etapa: Elemento filtrante
con vaso decantador

Filtro doble con 1 elemento filtrante, 1 malla filtrante y 2 vasos

DEUTZ BF 6L 913**FC 151/25A**

> '77

Filtro Doble con 1 elemento filtrante primario, 1 secundario y vaso cónico

DEUTZ F2L 514 / F3L514 / A4L514**FC 151/35**Entrada derecha con
rosca de 14 x 1.5 mm

Filtro de combustible con unidad sellada

DEUTZ**FC 151/36**Entrada y salida de
rosca de 14 mm x 1.5

Filtro de combustible simple

DEUTZ**FC 151/36B**Rosca de 1/8 gas
p/ manguera

Filtro de combustible simple

DEUTZ

REPUESTOS

FC 151/36B



Rosca de 1/8 gas
p/ manguera

Filtro de combustible simple

DEUTZ

REPUESTOS

FM 152/1



Bosch
1450410011

Metálico - De vasito bombita alim. y prefiltro t/ Bosch

DEUTZ

FM 152/3



Bosch
1450410011

Plástico - de vasito bombita alim. y prefiltro t/ Bosch

DEUTZ

FM 152/4



Bosch
2440401003

Largo interior bulón para bombita alim. Tipo Bosch

DEUTZ

FM 152/4P



Plastico interior para bulon
14x1.5mm y 16.15mm

Largo interior bulón para bombita alim. Tipo Bosch

DEUTZ

FM 152/8



Para prefiltro

DEUTZ

FM 152/9



De trampa de agua universal

DEUTZ

FM 152/11



Perkins
006 091
Deutz
301 9871
302 4115

Con aro plástico para prefiltro

DEUTZ

FM 152/12



Perkins
006 091
Deutz
301 9871
302 4115

Con aro metálico para prefiltro

DEUTZ

FM 152/19



Filtro de tanque OA 101 Carroceria "EL DETALLE"

DEUTZ

FM 152/20



Filtro de tanque

DEUTZ TRACTOR A85

REPUESTOS

JR 155/60**Bosch**
2 447 010 017Ref. 1 **1-JUN 156/66A (2 440 109 005)**
Ref. 2 **1-FM 152/1 (1 450 410 011)**
Ref. 3 **1-RB 180/3 (2 454 642 000)**
Ref. 4 **1-VAS 225/21L (2 459 999 002)**

Kit de reparación para bomba alimentadora tipo Bosch con vaso liso

VS

JR 155/64

Diam 6 mm



Conjunto de reparación de emergencia para mangueras de poliamida

VS

JR 155/65

Diam 8 mm



Conjunto de reparación de emergencia para mangueras de poliamida

VS

REPUESTOS

JR 155/66

Diam 11 mm



Conjunto de reparación de emergencia para mangueras de poliamida

VS

JR 155/67

Diam 12 mm



Conjunto de reparación de emergencia para mangueras de poliamida

VS

JR 155/79



1



2



3



1



2



3

Bosch
2 447 010 011

Ref. 1 2-AC 115/2 (1 230 203 001)
Ref. 2 2-VAL 222/1 (2 443 123 021)
Ref. 3 2-RB 180/4 (2 444 615 006)

Kit de reparación para bomba alimentadora tipo Bosch

VS

JR 155/81

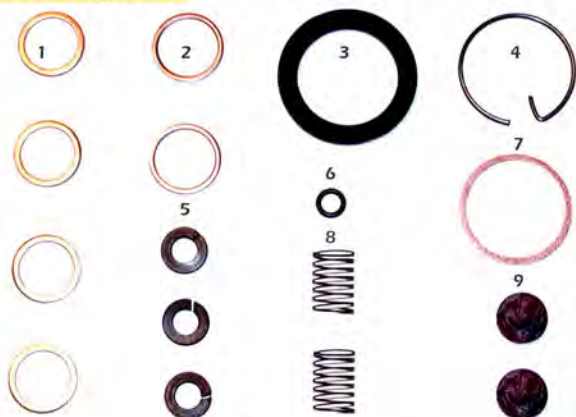

Bosch
9 441 080 020

- Ref. 1 4-AC 115/24 (2 916 710 610)
- Ref. 2 2-AC 115/2 (1 230 203 001)
- Ref. 3 1-JUN 156/66 (2 440 109 005)
- Ref. 4 1-SV 190/1 (2 444 601 000)
- Ref. 5 3-AG 105/1 (2 916 690 005)
- Ref. 6 1-AG 122/75 (1 900 210 100)
- Ref. 7 1-AC 115/1 (2 440 105 000)
- Ref. 8 2-RB 180/4 (2 444 615 006)
- Ref. 9 2-VAL 222/1 (2 443 123 021)

Kit de reparación para bomba alimentadora tipo Bosch

VS

JR 155/82

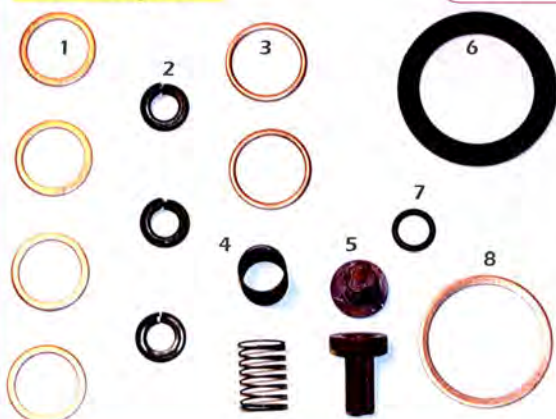

Bosch
9 441 080 175

- Ref. 1 4-AC 115/24 (2 916 710 610)
- Ref. 2 3-AG 105/1 (2 916 690 005)
- Ref. 3 2-AC 115/2 (1 230 203 001)
- Ref. 4 2-RB 180/4 (2 444 615 006)
- Ref. 5 2-VAL 222/1 (2 443 123 021)
- Ref. 6 1-JUN 156/66A (2 440 109 005)
- Ref. 7 1-AG 122/75 (1 900 210 100)
- Ref. 8 1-AC 115/1 (2 440 105 000)

Kit de reparación para bomba alimentadora tipo Bosch

VS

JR 155/83



Bosch
2 447 010 016
2 447 010 003

- Ref. 1 1-JUN 156/66A (2 440 109 005)
- Ref. 2 1-FM 152/1 (1 450 410 011)
- Ref. 3 1-RB 180/3 (2 454 642 000)

Kit de reparación para bomba alimentadora tipo Bosch y prefiltro tipo Bosch

VS

REPUESTOS

JR 155/84



Ref. Original

Bosch
2 447 010 004

- Ref. 1 2-AC 115/2 (1 230 203 001)
- Ref. 2 1-AG 122/75 (1 900 210 100)
- Ref. 3 2-VAL 222/1 (2 443 123 021)
- Ref. 4 2-RB 180/4 (2 444 615 006)
- Ref. 5 4-AC 115/24 (2 916 710 610)
- Ref. 6 1-JUN 156/1 (1 411 073 002)
- Ref. 7 1-AC 115/1 (2 440 105 000)
- Ref. 8 1-SV 190/1 (2 444 601 000)

Kit de reparación para bomba alimentadora tipo Bosch

VS

JR 155/85

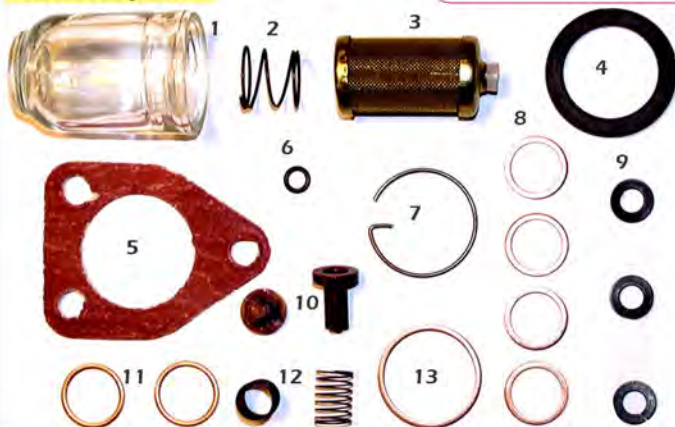

Ref. Original

Bosch
2 447 010 004Z

- Ref. 1 1-VAS 225/21L (2 459 999 002)
- Ref. 2 1-RB 180/3 (2 454 642 000)
- Ref. 3 1-FM 152/1 (1 450 410 011)
- Ref. 4 1-JUN 156/66 (2 440 109 005)
- Ref. 5 1-JUN 156/1 (1 411 073 002)
- Ref. 6 1-AG 122/75 (1 900 210 100)
- Ref. 7 1-SV 190/1 (2 444 601 000)
- Ref. 8 4-AC 115/24 (2 916 710 610)
- Ref. 9 3-AG 105/1 (2 916 690 005)
- Ref. 10 2-VAL 222/1 (2 443 123 021)
- Ref. 11 2-AC 115/2 (1 230 203 001)
- Ref. 12 2-RB 180/4 (2 444 615 006)
- Ref. 13 1-AC 115/1 (2 440 105 000)

Kit de reparación para bomba alimentadora tipo Bosch
y prefiltro tipo Bosch

VS

JR 155/86



Ref. Original

Bosch
2 447 010 004S

- Ref. 1 1-VAS 225/21L (2 459 999 002)
- Ref. 2 1-RB 180/3 (2 454 642 000)
- Ref. 3 1-FM 152/1 (1 450 410 011)
- Ref. 4 1-JUN 156/66 (2 440 109 005)
- Ref. 5 1-CM 133/1R (2 447 222 016R)
- Ref. 6 1-SV 190/1 (2 444 601 000)
- Ref. 7 2-AC 115/2 (1 230 203 001)
- Ref. 8 3-AG 105/1 (2 916 690 005)
- Ref. 9 2-VAL 222/1 (2 443 123 021)
- Ref. 10 2-RB 180/4 (2 444 615 006)
- Ref. 11 4-AC 115/24 (2 916 710 610)
- Ref. 12 1-JUN 156/1 (1 411 073 002)
- Ref. 13 1-AG 122/75 (1 900 210 100)
- Ref. 14 1-AC 115/1 (2 440 105 000)

Kit de reparación para bomba alimentadora tipo Bosch

VS

REPUESTOS

JR 155/87

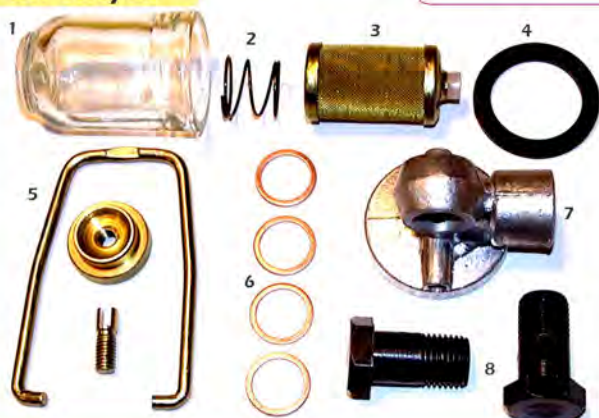

Bosch
1 457 434 000

- Ref. 1 1-VAS 225/21L (2 459 999 002)
- Ref. 2 1-RB 180/3 (2 454 642 000)
- Ref. 3 1-FM 152/1 (1 450 410 011)
- Ref. 4 1-JUN 156/66 (2 440 109 005)
- Ref. 5 1-SV 190/9 (9 441 080 033)
- Ref. 6 4-AC 115/24 (2 916 710 610)
- Ref. 7 1-TV 194/2 (2 459 999 001)
- Ref. 8 2-BP 129/16 (2 916 710 610)

Kit de reparación para bomba alimentadora tipo Bosch

VS

JR 155/92



Para tubo de retorno

DEUTZ

JUN 156/1**Bosch**
1 411 073 002

Junta para base de acople para bombita tipo A

DEUTZ**JUN 156/8**

Junta para base de bomba alim. Tipo A mod. Nuevo angosta

DEUTZ**JUN 156/45****Bosch**
1 411 015 083

Junta de goma, 3 cilindros

DEUTZ - FIAT**JUN 156/57**

Junta tipo A de goma, 8 cilindros

DEUTZ**JUN 156/65A**

Junta de goma tipo A, 5 cilindros

DEUTZ**JUN 156/65C**

Junta 2 cilindros

DEUTZ



JUEGO DE JUNTAS PARA TURBO

156-8

1

REPUESTOS

JUN 156/302T

Juego de junta para turbo

DEUTZ BF6L913 ECOLÓGICO APL302

JUN 156/913T

Juego de junta para turbo

DEUTZ TRACTOR/CAMION BF6L913 3LEP289

LA 158/4



Lámina de acople

DEUTZ

LA 158/4/AC

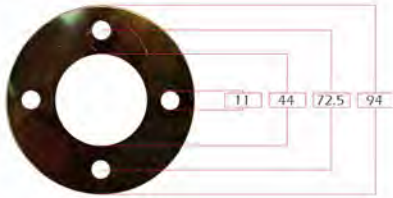

Lámina de acople. Acero reforzado

DEUTZ

LA 158/17

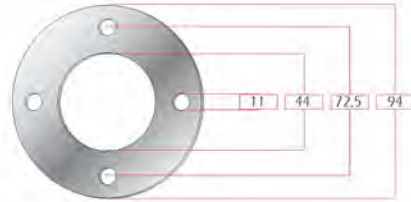

Lámina de acople

DEUTZ

LA 158/17/AC

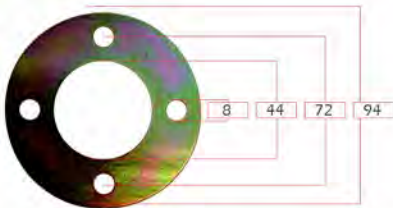

Lámina de acople. Acero reforzado

DEUTZ

BA 130/36Trazo 1/8" - Color **Amarillo**

Contenido Neto **60** cm³

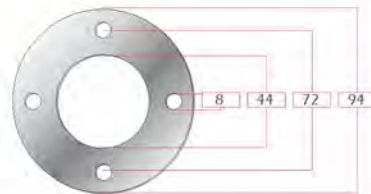
Para marcar, numerar y codificar todo tipo de metales, plástico, maderas, gomas, cerámicas, etc. Escribe inclusive sobre superficies aceitosas y rústicas. Resiste temperatura e intemperie, provisto en envase de plástico, flexible y anatómico.

REPUESTOS

PLQ 164/5



Bosch
2 430 136 202
2 430 136 015

De inyector

DEUTZ 913

PT 170/12



Bosch
2 457 434 009

Portatobera large

DEUTZ 514

PT 170/22



Bosch
2 433 314 153
2 433 314 120
2 433 314 256

Portatobera

DEUTZ 913

PT 170/24



Bosch
2 433 314 164
2 433 317 288

Portatobera

DEUTZ 1114/2114

RAC 173/5

14 x 18

**Bosch**
1 413 462 081

Racord lateral conexión

DEUTZ**RAC 173/31****Bosch**
2 443 355 000

Racord de válvula bomba alimentadora

DEUTZ**RAC 173/32**

14/16 x 1,5 mm

**Bosch**
2 442 457 000

Racord de salida de bomba de llenado

DEUTZ**RAC 173/33****Bosch**
2 447 010 015

Racord de entrada bomba llenado

DEUTZ

REPUESTOS

RAC 173/111**Bosch**
1 413 372 072

Racord modelo nuevo

DEUTZ**RAC 173/123**

Salida 14mm

**Bosch**
9 401 083 327

Racord con válvula

DEUTZ**RAC 173/124**

Salida 12mm

**Bosch**
1 413 372 091

Racord con válvula

DEUTZ 1722

SCI 188/8



Seguro para 3 caños

DEUTZ

SCI 188/9



Seguro para 2 caños

DEUTZ

SCI 188/14



Seguro para 4 caños

DEUTZ

SCI 188/15



Seguro para 6 caños

DEUTZ

SCI 188/16

Deutz
03366473

OA 101 (1 Caño)

DEUTZ

SCI 188/17

Deutz
03361809

OA 101 (2 Caños)

DEUTZ

SCI 188/18



Seguro para 5 caños

DEUTZ

SO 191/12**12 Volts**

Bosch
9 461 610 533
9 461 610 530
0 330 001 015
0 330 001 018
0 330 001 028

Zexel
146650-0720
146650-1220

Lucas/Delphi
7240-5

Iveco/Fiat
9946984
8190393

Bomba BOSCH VE

DEUTZ**SO 191/13****24 Volts**

Bosch
9 461 612 164
9 461 610 997
0 330 001 016
0 330 001 027
0 330 001 046

Zexel
146650-0820
146650-0420
146650-1320

Lucas/Delphi
7240-6

Nipon Denso
096030-0170
096030-0080

Bomba BOSCH VE

DEUTZ**SO 191/16****24 Volts**

Lucas/Delphi
7180-049
7180-049A
7180-049B
9003-036

Bomba CAV DPA/DPC

DEUTZ

SO 191/84C



Solenoides de pare completo

**MAQUINAS VIALES / ESTACIONARIOS
CUMMINS / DEUTZ**

SO 191/99C



Solenoides de pare completo

JOHN DEERE / DEUTZ F6L913 C / BOMBA RSV

SO 191/99CK



Solenoides de pare completo - corto

JOHN DEERE / DEUTZ F6L913 C / BOMBA RSV

SO 191/100C



Solenoides de pare completo

JOHN DEERE / DEUTZ

SO 191/100CK



Solenoides de pare completo - Corto

JOHN DEERE / DEUTZ

SO 191/131C



Solenoides de pare completo

**MAQUINAS VIALES / ESTACIONARIOS
DEUTZ 2011**

SO 191/137C

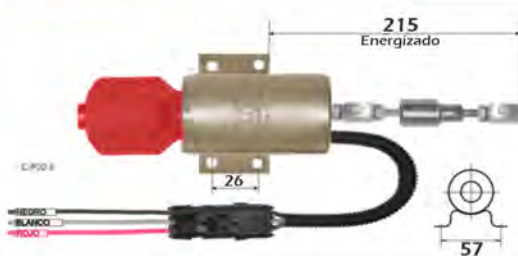

Solenoides de pare completo

DEUTZ

SO 191/138C

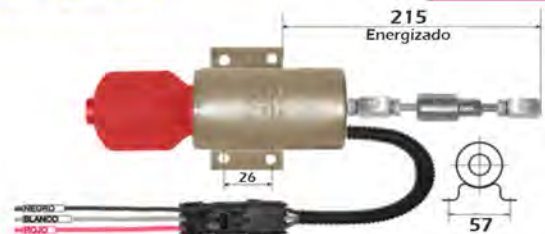

Solenoides de pare completo

DEUTZ

REPUESTOS

TV 194/2

R= 14 x 1.5



Bosch
2 459 999 001
Iveco
1290638

Soporte prefiltro bomba alimentadora tipo Bosch

VS

TV 194/5/1

R= 1/2" x 20 UNF
ENTRADA DERECHA



Soporte prefiltro

DEUTZ

TV 194/5/3

R= 14 x 1.5



Soporte prefiltro

DEUTZ

TV 194/25



Deutz
4003625

Tapa de filtro

DEUTZ AGRALE / DYNAMIC

TV 194/26



Tapa de filtro p/ trampa de agua universal (FC 151/20) 2 salidas

VS

TV 194/27

R= 14 x 1.5



Tapa de filtro para trampa de agua

DEUTZ

TV 194/30

R= 14 x 1.5



Tapa de duofiltro de combustible

DEUTZ

TV 194/31

R= 14 x 1.5



Bosch
0301 9999

Tapa duofiltro

DEUTZ BFGL 913

TV 194/32

R= 14 x 1.5



Tapa duofiltro de combustible

DEUTZ

TV 194/36



Tapa duofiltro 1 litro

MAGIRUS - DEUTZ 6 CIL

TV 194/37

14 mm



Tapa filtro simple comb. Unidad sellada ent. derecha

DEUTZ

CI 140/101A

R= 14mm

CI 140/101A

R= 12mm

CI 140/101A

R= 1/8mm



Para filtro interior

DEUTZ

UN 217/16

12 mm



Unión de acero con vástago de 7 mm

DEUTZ**UN 217/17**

12 mm



Unión de acero con vástago de 8 mm

DEUTZ**UN 217/18**

12 mm



Unión de acero con vástago de 9 mm

DEUTZ**UN 217/19**

13 mm



Unión de acero con vástago de 8 mm

DEUTZ**UN 217/20**

13 mm



Unión de acero con vástago de 9 mm

DEUTZ**UN 217/21**

13 mm



Unión de acero con vástago de 10 mm

DEUTZ**UN 217/22**

14 mm



Unión de acero con vástago de 8 mm

DEUTZ**Lucas**
9007200R**UN 217/23**

14 mm



Unión de acero con vástago de 9 mm

DEUTZ**Bosch**
2916693012**UN 217/24**

14 mm



Unión de acero con vástago de 10 mm

DEUTZ**Bosch**
2916693013**UN 217/25**

10 mm



Unión de acero con vástago de 7 mm

DEUTZ

UN 217/26

12 mm



Unión de acero con vástago de 7 mm

DEUTZ

UN 217/27

16 mm



Unión de acero con vástago de 12 mm

DEUTZ

UC 218/PE06	Para Poliamida de 6 mm
UC 218/PE08	Para Poliamida de 8 mm
UC 218/PE10	Para Poliamida de 10 mm
UC 218/PE12	Para Poliamida de 12 mm
UC 218/PE14	Para Poliamida de 14 mm
UC 218/PE16	Para Poliamida de 16 mm
UC 218/PE1/4	Para Poliamida de 1/4"
UC 218/PE3/8	Para Poliamida de 3/8"
UC 218/PE1/2	Para Poliamida de 1/2"
UC 218/PE5/16	Para Poliamida de 5/16"



Union Conectora para Poliamida
(TEE - Tubo - Tubo) Modelo PE

VS

UC 218/PU06	Para Poliamida de 6 mm
UC 218/PU08	Para Poliamida de 8 mm
UC 218/PU10	Para Poliamida de 10 mm
UC 218/PU12	Para Poliamida de 12 mm
UC 218/PU14	Para Poliamida de 14 mm
UC 218/PU16	Para Poliamida de 16 mm
UC 218/PU1/4	Para Poliamida de 1/4"
UC 218/PU3/8	Para Poliamida de 3/8"
UC 218/PU1/2	Para Poliamida de 1/2"
UC 218/PU5/16	Para Poliamida de 5/16"



Union Conectora para Poliamida
(Tubo - Tubo) Modelo PU

VS

UC 218/PV04	Para Poliamida de 4 mm
UC 218/PV06	Para Poliamida de 6 mm
UC 218/PV08	Para Poliamida de 8 mm
UC 218/PV10	Para Poliamida de 10 mm
UC 218/PV12	Para Poliamida de 12 mm
UC 218/PV1/4	Para Poliamida de 1/4"
UC 218/PV3/8	Para Poliamida de 3/8"
UC 218/PV1/2	Para Poliamida de 1/2"
UC 218/PV5/16	Para Poliamida de 5/16"



Union Conectora para Poliamida
(Tubo - 90°) Modelo Pv

VS

VAL 221/2**Bosch**
1 457 413 010

Válvula

DEUTZ**VAL 221/5****Bosch**
1 417 413 001

Válvula

DEUTZ**VAL 221/6****Bosch**
1 417 413 000

Válvula

DEUTZ**VAL 221/8**

Válvula

DEUTZ**VAL 221/17****Bosch**
1 417 413 047

Válvula

DEUTZ**VAL 221/41****Bosch**
1 110 010 027
Man
51103040358

Válvula limitadora de presión para rampa Common Rail

DEUTZ AGRALE 8500 E-TRONIC MOTOR 3.0L - 4.08 TCE

VAL 222/1

Bosch
2 443 123 021

Para bomba alimentadora tipo Bosch (Todas) color roja

DEUTZ**VAL 222/2**

Bosch
2 443 203 001
1 414 027 300

Lucas Delphi
7027121

Para bomba alimentadora tipo Bosch (Todas) color blanca

DEUTZ**VAL 222/3**

Ø 19mm



Lucas Delphi
7092256A
AC5593866

Tubería tecalan (1/2), flexible para agua refrigeración de compresor

DEUTZ**VAL 222/4**

Ø 18mm



Bosch
2 447 419 002
2 447 419 002

Tubería tecalan (3/8), flexible para agua refrigeración de compresor

DEUTZ

VAS 225/4



Tipo CAV - plástico

VAS 225/15



Tipo CAV - plástico especial

VAS 225/17



Cónico, agujero chico. Plástico especial

DEUTZ

VAS 225/21L



Bosch
2 459 999 002

Para prefiltro tipo Bosch liso - De vidrio

DEUTZ

VAS 225/24



Recto, para prefiltro

Perkins
002894
7111403

PERKINS - DEUTZ - RENAULT - MERCEDES BENZ - VS

VAS 225/27**Deutz**
3009691

Vaso cónico, agujero chico para trampa de agua - De vidrio

DEUTZ**VAS 225/29**

Vaso para bombita alimentadora - De vidrio

DEUTZ**VAS 225/33****Bosch**
2 447 010 015

Vaso para prefiltro tipo Bosch

DEUTZ**VAS 225/35**

Vaso tipo CAV, recto

DEUTZ**VAS 225/37****Bosch**
2 447 010 015

Vaso cónico, agujero chico para trampa de agua

DEUTZ**VAS 225/39**

Vaso para filtro de 1 litro

DEUTZ

VAS 225/43



Deutz
101001

Vaso cilíndrico universal

DETUZ

VAS 225/44



Vaso colector de polvo

DETUZ

VAS 225/44T



Vaso colector de polvo transparente

DETUZ

VAS 225/45



Vaso colector de polvo

DETUZ A130

VAS225/45T



Vaso colector de polvo transparente

DETUZ A130

cm1122-870

Inyector
0445120043

Bosch
0433171870

Tobera Common rail - DLLA143P1404

**AGRALE 8500 - DEUTZ 9200 7.5/8.5/7.2 E-TRONIC
VOLKSWAGEN CONSTELLATION 31.26 CE**

cm1122-964

Inyectores
0445120066
0986435548

Bosch
0433171964
Renault
7422017818
Volvo
7422017818

Tobera common rail - DLLA144P1565

**VOLVO G900 D7D DEUTZ / G900 /
EXCAVADORA EC240 B/C D6D DEUTZ**



Tuberías

para linea

DEUTZ

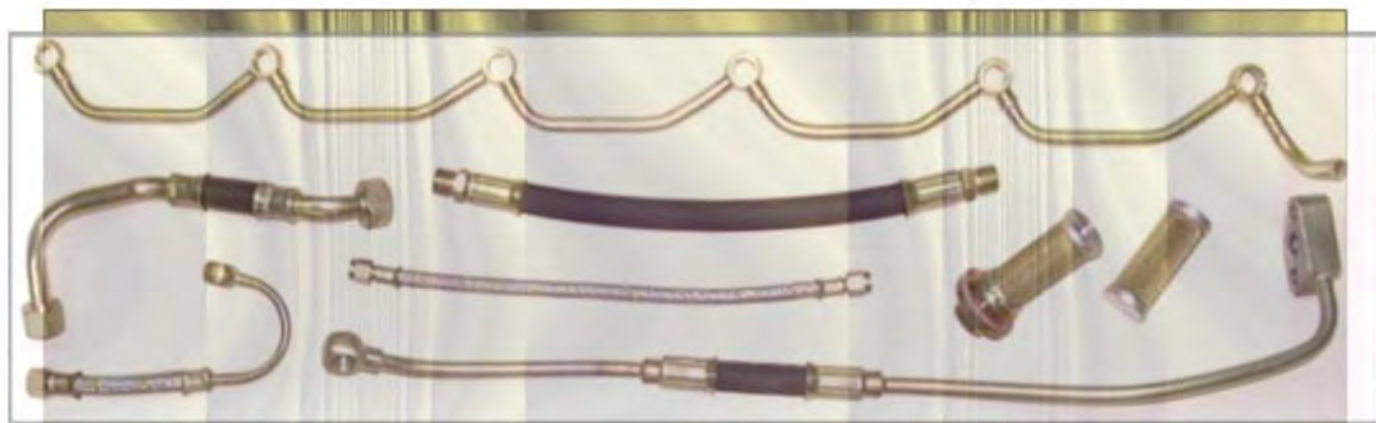

TUBERIAS FLEXIBLES Y RIGIDAS PARA LUBRICACION, COMBUSTIBLE, INYECCION, FRENO, ALTA, MEDIA Y BAJA PRESION, COMANDOS Y DIRECCIONES HIDRAULICAS

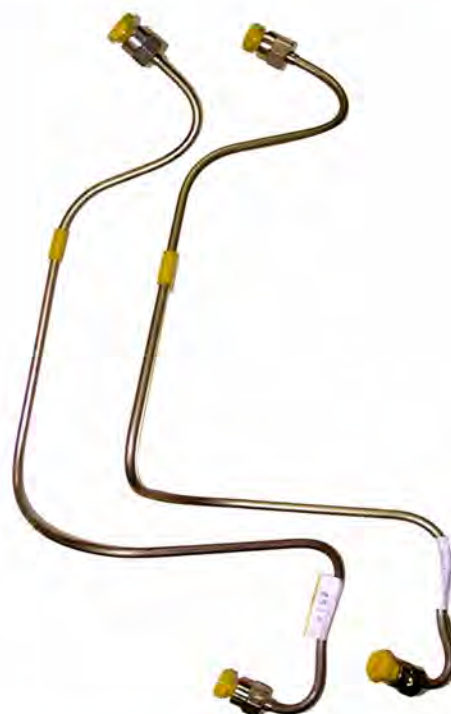
Cód. CMD **D 1**Cód. CMD **D 2****DEUTZ 514 - 1 CILINDRO****DEUTZ 30HP 712/812 (PAPER0)**Cód. CMD **D 3**Cód. CMD **D 4****DEUTZ F2 L514 30/35HP BOMBA DEUTZ****DEUTZ F2 L-514 30/35HP BOMBA BOSCH**

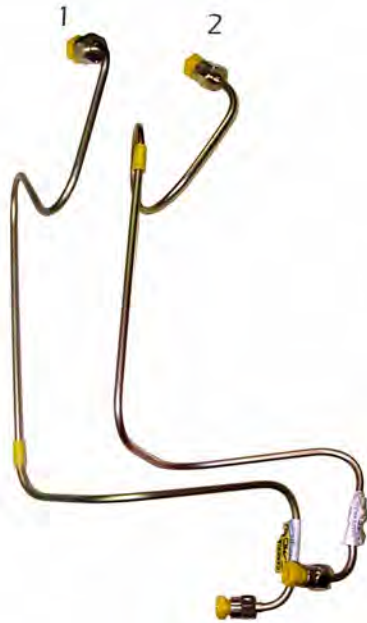
Cód. CMD D 5**DEUTZ F2 L-114/2114 INY. DIRECTA 45HP****Cód. CMD D 6****DEUTZ F3 L-514 45/55 BOMBA DEUTZ****Cód. CMD D 7****DEUTZ F3 L-514 45/55 BOMBA BOSCH****Cód. CMD D 8****DEUTZ F3 L-1114/2114 INY. DIRECTA 65HP**

Cód. CMD D 10



DEUTZ F4 L-514 70 HP - 4 CILINDROS

Cód. CMD D 11



DEUTZ F4 L-1114/2114 INYECCIÓN DIRECTA 85 HP

Cód. CMD D 12



DEUTZ F6 L-514 110 HP - 6 CILINDROS

Cód. CMD D 13

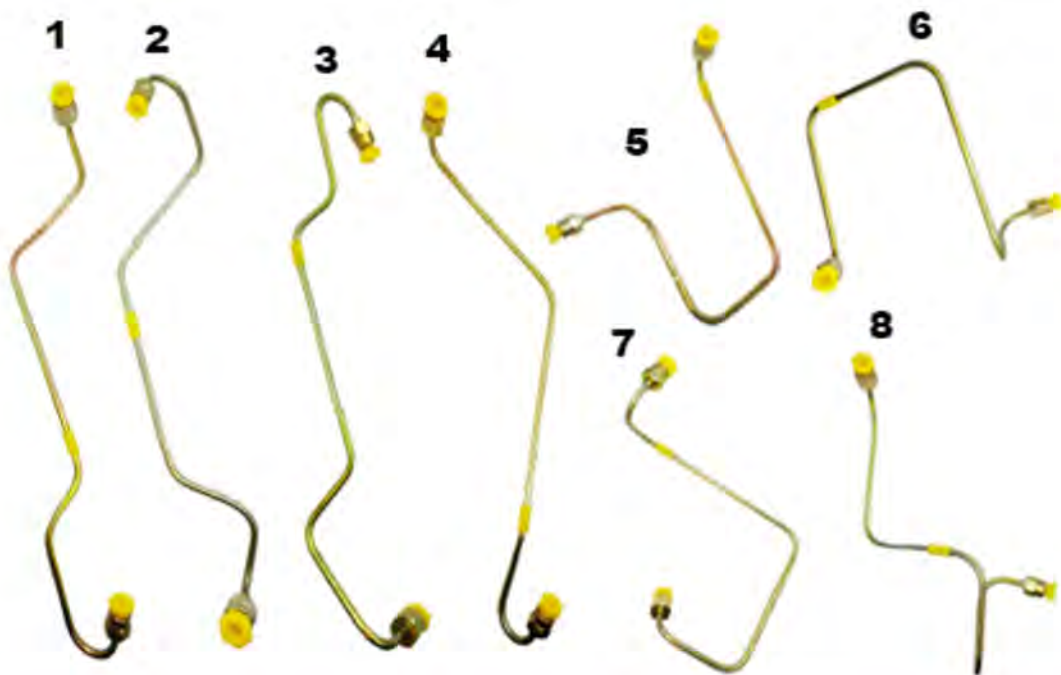
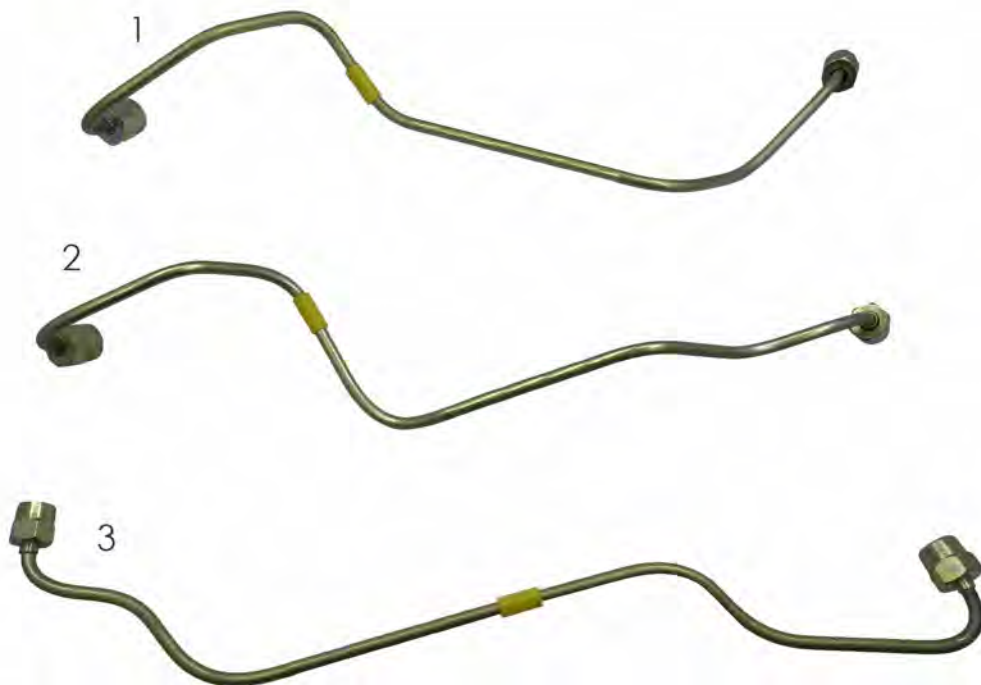

DEUTZ F6 L-1114/2114 INYECCIÓN DIRECTA 130 HP

Cód. CMD **D 14****DEUTZ MAGIRUS F8 L-413 OMNIBUS Y CAMIÓN - 8 CILINDROS**Cód. CMD **D 15****DEUTZ F3 L-913 3 CILINDROS**

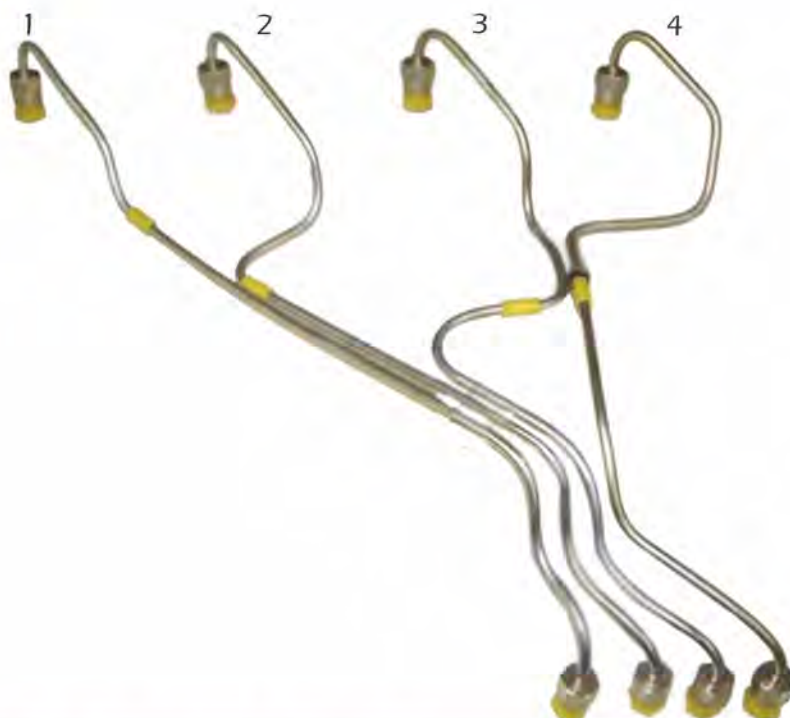
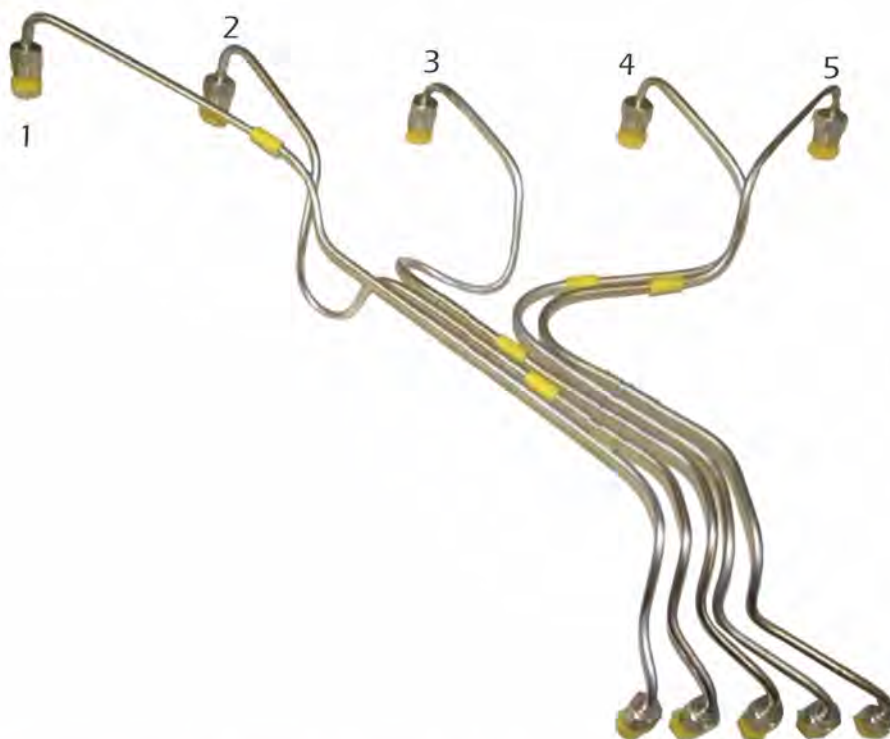
Cód. CMD D 16**Deutz**
301 8184**DEUTZ F4 L-913 BOMBA LINEAL - 4 CILINDROS****Cód. CMD D 17****Deutz**
301 8837**DEUTZ F5 L-913 5 CILINDROS**

Cód. CMD D 18

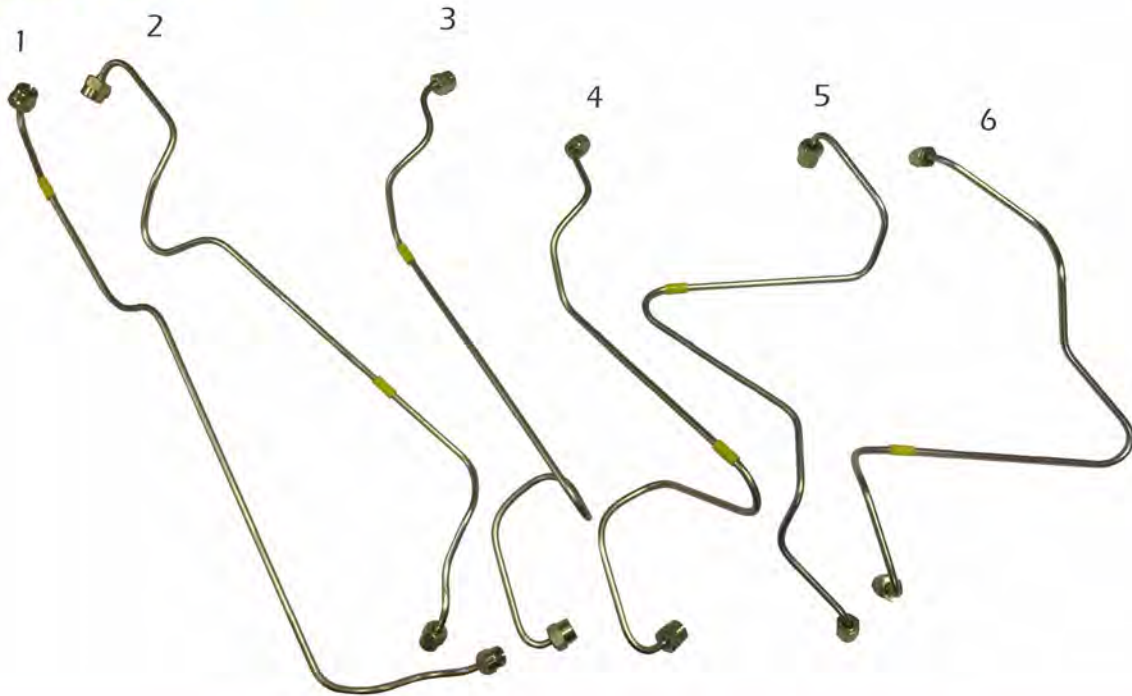

Deutz
301 8199

DEUTZ F6 L-913 - 6 CILINDROS

Cód. CMD D 19

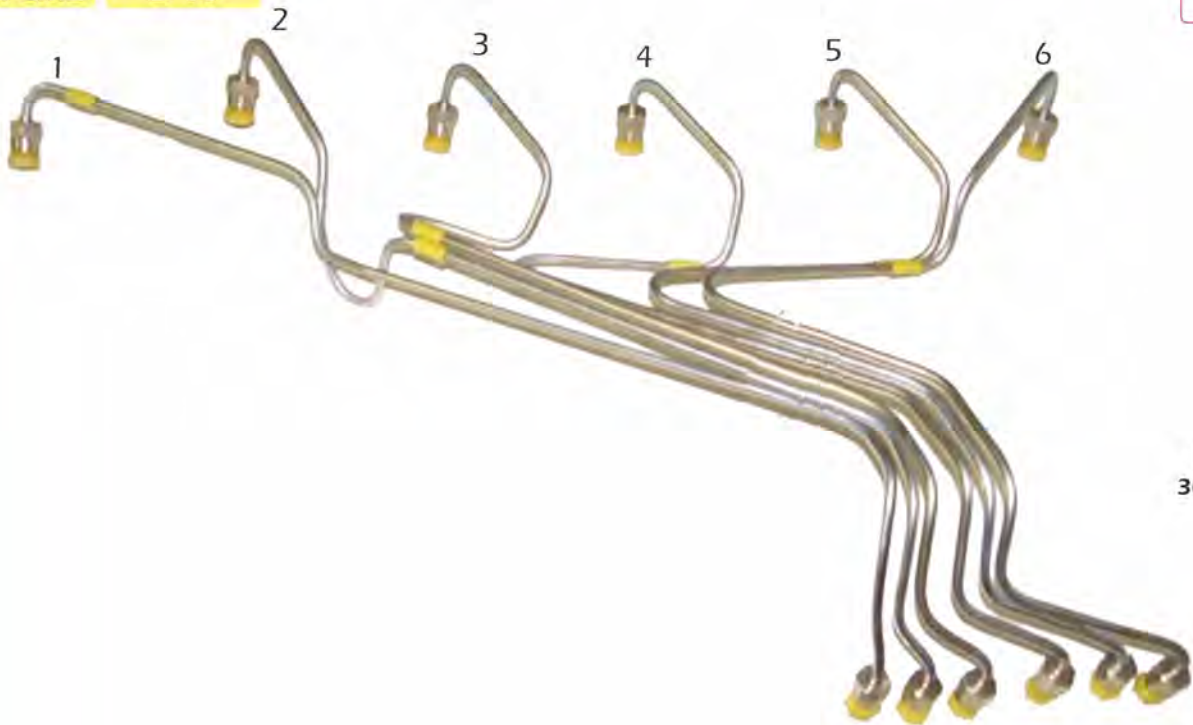

Deutz
301 8236

DEUTZ Bf6 L-913 TURBO - 6 CILINDROS

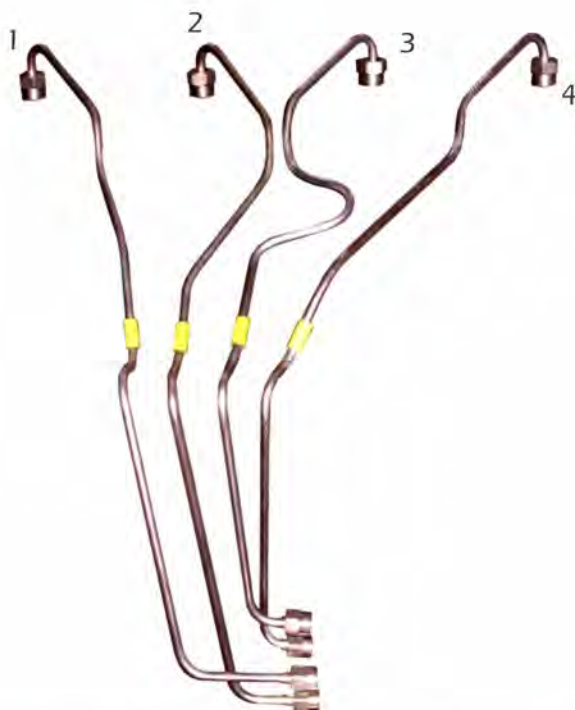
Cód. CMD D 20

Deutz
307 2243
307 2247
307 2248
307 2249
307 2250

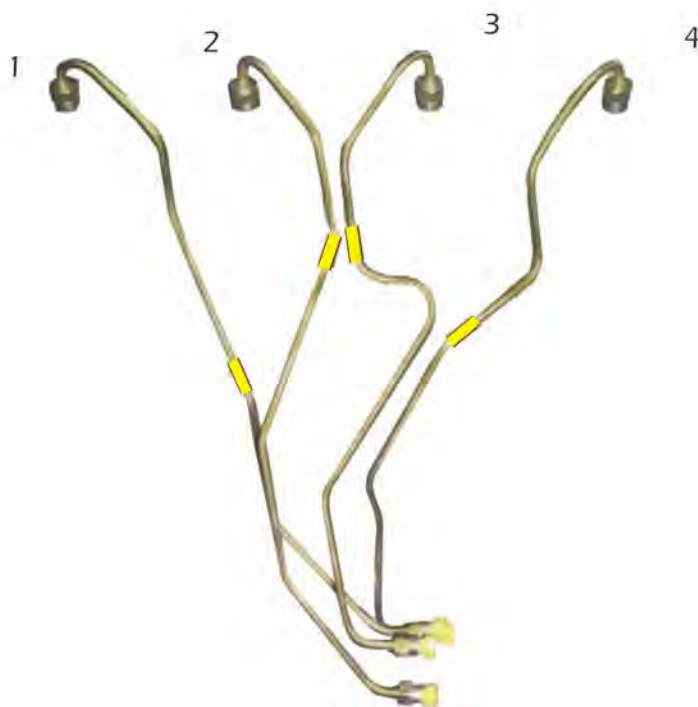
DEUTZ F4 L-913 - BOMBA ROTATIVA - 4 CILINDROS**Cód. CMD D 21****DEUTZ Bf4 L-913 TURBO - 4 CILINDROS (BOMBA ROTATIVA)**

Cód. CMD D 22

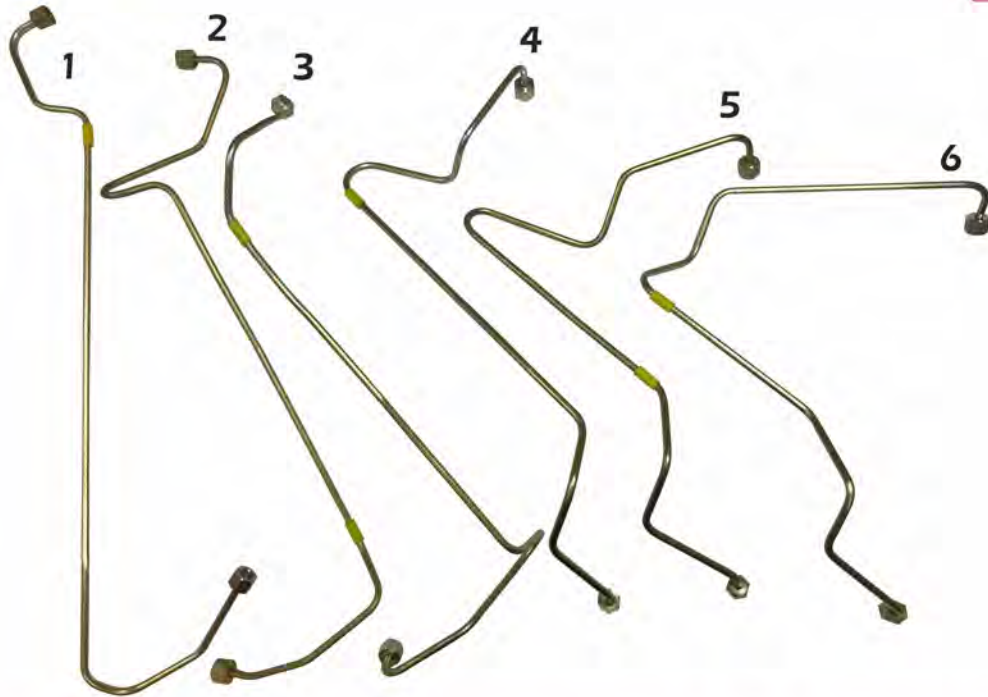

DEUTZ BF 6L CON TURBO POST ENFRIADO - 6 CILINDROS

Cód. CMD D 23 MX



DEUTZ BF 4M 1011

Cód. CMD D 24



Deutz
02111918

DEUTZ MECÁNICO BF 4 - BM6L 1013C



MV 1001	Uniones cruzadas	200 mm	MV 1002	Uniones paralelas	200 mm
MV 1003	Uniones cruzadas	250 mm	MV 1004	Uniones paralelas	250 mm
MV 1005	Uniones cruzadas	300 mm	MV 1006	Uniones paralelas	300 mm
MV 1007	Uniones cruzadas	350 mm	MV 1006 9,5	Uniones paralelas	300 mm
MV 1007 9,5	Uniones cruzadas	350 mm	MV 1008	Uniones paralelas	350 mm
MV 1009	Uniones cruzadas	400 mm	MV 1010	Uniones paralelas	400 mm
MV 1011	Uniones cruzadas	450 mm	MV 1010 9,5	Uniones paralelas	400 mm
MV 1011 9,5	Uniones cruzadas	450 mm	MV 1012	Uniones paralelas	450 mm
MV 1013	Uniones cruzadas	500 mm	MV 1014	Uniones paralelas	500 mm
MV 1015	Uniones cruzadas	550 mm	MV 1014 9,5	Uniones paralelas	500 mm
MV 1015 9,5	Uniones cruzadas	550 mm	MV 1016	Uniones paralelas	550 mm
MV 1017	Uniones cruzadas	600 mm	MV 1018	Uniones paralelas	600 mm
MV 1017 9,5	Uniones cruzadas	600 mm	MV 1018 9,5	Uniones paralelas	600 mm
MV 1019	Uniones cruzadas	650 mm	MV 1020	Uniones paralelas	650 mm
MV 1021	Uniones cruzadas	700 mm	MV 1020 9,5	Uniones paralelas	650 mm
MV 1021 9,5	Uniones cruzadas	700 mm	MV 1022	Uniones paralelas	700 mm
MV 1023	Uniones cruzadas	750 mm	MV 1022 9,5	Uniones paralelas	700 mm
MV 1025	Uniones cruzadas	800 mm	MV 1024	Uniones paralelas	750 mm
MV 1027	Uniones cruzadas	850 mm	MV 1024 9,5	Uniones paralelas	750 mm
MV 1029	Uniones cruzadas	900 mm	MV 1026	Uniones paralelas	800 mm
MV 1029 9,5	Uniones cruzadas	900 mm	MV 1026 9,5	Uniones paralelas	800 mm
MV 1031	Uniones cruzadas	950 mm	MV 1028	Uniones paralelas	850 mm
MV 1033	Uniones cruzadas	1000 mm	MV 1028 9,5	Uniones paralelas	850 mm
MV 1035	Uniones cruzadas	1050 mm	MV 1030	Uniones paralelas	900 mm
MV 1037	Uniones cruzadas	1100 mm	MV 1030 9,5	Uniones paralelas	900 mm
MV 1039	Uniones cruzadas	1150 mm	MV 1032	Uniones paralelas	950 mm
MV 1041	Uniones cruzadas	1200 mm	MV 1034	Uniones paralelas	1000 mm
MV 1043	Uniones cruzadas	1250 mm	MV 1034 9,5	Uniones paralelas	1000 mm
MV 1045	Uniones cruzadas	1300 mm	MV 1036	Uniones paralelas	1050 mm
MV 1047	Uniones cruzadas	1350 mm	MV 1038	Uniones paralelas	1100 mm
MV 1049	Uniones cruzadas	1400 mm	MV 1038 9,5	Uniones paralelas	1100 mm
MV 1051	Uniones cruzadas	1450 mm	MV 1040	Uniones paralelas	1150 mm
MV 1053	Uniones cruzadas	1500 mm	MV 1042	Uniones paralelas	1200 mm
			MV 1042 9,5	Uniones paralelas	1200 mm
			MV 1044	Uniones paralelas	1250 mm
			MV 1046	Uniones paralelas	1300 mm
MV 1050 9,5	Uniones paralelas	1400 mm	MV 1048	Uniones paralelas	1350 mm
MV 1052	Uniones paralelas	1450 mm	MV 1048 9,5	Uniones paralelas	1350 mm
MV 1054	Uniones paralelas	1500 mm	MV 1050	Uniones paralelas	1400 mm

MV 0082



Tubería colector de rebase de inyectores F3L514

DEUTZ

MV 0094



Deutz
03359499

Tubería de retorno

DEUTZ A 85

MV 0105



Deutz
3000145

Colector rebase de inyectores

DEUTZ F4L514

MV 0122



Deutz
3000138

Colector rebase de inyectores

DEUTZ A F6L514

MV 1131



Tubería salida de tanque de combustible

DEUTZ

MV 1133



Tubería de retorno de combustible

DEUTZ

MV 1152



Tubería alimentación de combustible

DEUTZ

MV 1162



Tubería flexible de combustible

DEUTZ

MV 1165



Tubería de alimentación de combustible

MV 1166



Tubería flexible de combustible

MV 1169



Tubería de retorno de combustible

DEUTZ A85

Deutz
3016749

MV 1170



Tubería flexible de combustible

DEUTZ

MV 1194



Retorno rebase inyección

DEUTZ A130

Deutz
3366218

MV 1303



Tubería de bomba de alimentación a filtro

DEUTZ F6L 913

Deutz
4004575

MV 1308**Deutz**
3021861

Cañería retorno de inyectores

DEUTZ F4L 913**MV 1309**

Tubería retorno de combustible

DEUTZ F4L 913**MV 1310****Deutz**
4008814

Tubería de múltiple de admisión a ABB

DEUTZ**MV 1311**

Tubería de admisión a TPS

DEUTZ BF6L913**MV 1312**

Tubería de múltiple de admisión a bomba inyección

DEUTZ BF6L913**MV 1314****Deutz**
1266160

Tubería alimentación de combustible, de filtro a bomba

DEUTZ F4L 913**MV 1315****Deutz**
3021744

Alimentación de bomba a filtro

DEUTZ F4L 913, BF6L 913**MV 1316****Deutz**
3021888

Tubería flexible de combustible

DEUTZ F4L 913

MV 1317**Deutz**
3021999

Flexible alimentación de combustible

DEUTZ F4L913**MV 1319****Deutz**
3021889

Tubería flexible de combustible

DEUTZ FL913**MV 1320****Deutz**
1266171

Tubería flexible para camión

DEUTZ STAR / DINAMIC
AGRALE DINAMIC / STARK**MV 1322****Deutz**
2137526

Tubería colector de rebase de inyectores

DEUTZ F4L913**MV 1350**

Tubería de retorno

DEUTZ

MV 1360**Deutz**
4004576

Tubería de filtro a bomba inyectora

DEUTZ F6L 913**MV 1361****Deutz**
2232346

Tubería retorno de inyectores

DEUTZ F6L 913**MV 1362****Deutz**
2137534

Tubería colector rebase de inyectores

DEUTZ F6L 913/BF6L 913**MV 1366****Deutz**
1231025

Tubería flexible de combustible

DEUTZ F6L 913**MV 1367****Deutz**
1231026

Tubería flexible de combustible

DEUTZ F6L 914**MV 1370****Deutz**
3016614

Tubería flexible de manómetro

DEUTZ 2114

MV 1374



Deutz
2232346

Tubería de retorno de inyectores

DEUTZ F4L 913 BOMBA ROTATIVA

MV 1376



Deutz
2232346

Tubería de bomba de alimentación a filtro

DEUTZ BF6L 913

MV 1377



Deutz
4004578

Tubería de filtro a bomba inyectora

DEUTZ BF6L 913

MV 1381



Deutz
2232348

Tubería retorno de inyectores

DEUTZ BF6L 913

MV 1382**Deutz**
3021871

Flexible de combustible

DEUTZ 230**MV 1385****Deutz**
0000

Tubería flexible de combustible

DEUTZ**MV 1392****Deutz**
3021278

Tubería flexible de combustible

DEUTZ**MV 1393****Deutz**
3021277

Tubería flexible alimentación de combustible

DEUTZ**MV 1399****Deutz**
0000

Tubería flexible de combustible

DEUTZ**MV 1397****Deutz**
1180505

Tubería flexible de combustible corto

DEUTZ BFM2012**MV 1398****Deutz**
1180504

Tubería flexible de combustible largo

DEUTZ BFM2012

MV 1414



Deutz
0411198

Caño flexible de combustible, filtro - AX5,80

DEUTZ

MV 1421



Deutz
4004963

Caño rígido filtro a bomba AX 4.60

DEUTZ

MV 1422



Deutz
3021277

Caño flexible alimentación de combustible

DEUTZ

MV 1423



Deutz
4005177

Caño rígido de tanque a filtro - AX 4.60/AX4.75

DEUTZ

MV 1424



Deutz
4005178

Caño rígido de bomba a filtro - AX 4.60/AX4.75

DEUTZ

MV 1431



Deutz
3021869

Caño flexible

DEUTZ BF6L 913

MV 1432

Largo 320 mm



Deutz
3021871

Caño flexible de bomba a filtro. AX4.60/AX4.76

DEUTZ

MV 1433**Cod. Orig.**
400 4214

Caño flexible BF6L914

DEUTZ**MV 1434****Cod. Orig.**
0490 0158

Caño flexible de bomba a filtro Ax 4.60 / Ax. 4.76

DEUTZ**MV 1435****Deutz**
4900159

Caño flexible de alimentación

DEUTZ**MV 1436****Deutz**
4900160

Caño flexible de alimentación

DEUTZ**MV 1439****Deutz**
1104100-66D
2003707
4110001009021

Tubería de rebose de combustible

DEUTZ PUMA D12 MOTOR BF6M 1013 FC EURO III.**MV 1439A****Deutz**
4501472

Tubería de rebose de combustible - 4 cilindros

DEUTZ PUMA D12 MOTOR BF4M 1013 FC EURO III.

MV 0635A

Tubería universal de manómetro

VARIOS**MV 0635B**

Tubería universal de manómetro

VARIOS**MV 0635C**

Tubería universal de manómetro

VARIOS**MV 0635D**

Tubería universal de manómetro

VARIOS**MV 0635E**

Tubería universal de manómetro

VARIOS**MV 0635F**

Tubería universal de manómetro

VARIOS**MV 0635G**

Tubería universal de manómetro

VARIOS

MV 1119**Deutz**
3001308

Flexible refrigerador de aceite

DEUTZ**MV 1151**

Tubería lubricación

DEUTZ**MV 1301****Deutz**
2139547

Tubería lubricación de turbo

DEUTZ BF6L913**MV 1305****Deutz**
2231641

Tubería lubricación bomba inyectora

DEUTZ F4L913**MV 1326****Deutz**
3029466

Tubería fusible completa de aceite

DEUTZ**MV 1327****Deutz**
4020166

Tubería fusible de aceite (Sin tuerca ni virola)

DEUTZ

MV 1328**Deutz**
04234669

Tubería lubricación de turbo

DEUTZ BF6L 914C**MV 1331****Deutz**
4011797

Tubería de lubricación forzada transmisión AX 4.120

DEUTZ**MV 1332****Deutz**
4013950

Tubería lubricación AX 5.145

DEUTZ**MV 1333****Deutz**
4013953

Tubería de entrada lubricación AX 5.145

DEUTZ**MV 1334****Deutz**
4012494

Tubería de retorno recto AX 5.65/AX 5.8

DEUTZ**MV 1335****Deutz**
4013944

Tubería de retorno lubricación AX 5.125

DEUTZ**MV 1336****Deutz**
4013876

Tubería lubricación forzada transm. TWA 1125

DEUTZ

MV 1337**Deutz**
4013910

De forzada transmisión TWA 1125

DEUTZ**MV 1338****Deutz**
4013947

De unión lubricación forzada transmisión TWA 1125

DEUTZ**MV 1339****Deutz**
4013866

Tramo 1 lubric. forzada transmisión TWA 1125/1325

DEUTZ**MV 1340****Deutz**
4013869

Tubería tecalan (3/8), flexible para agua refrigeración de compresor

DEUTZ**MV 1341****Deutz**
4013873

De presión lubric. forzada transmisión TWA 1125/1135

DEUTZ**MV 1342****Deutz**
4013907

C/unión esférica lubric. forzada trans. TWA 1125/1135

DEUTZ**MV 1343****Deutz**
4013941

Tubería de presión lubric. forzada transmisión TWA 1125/1135

DEUTZ**MV 1344****Deutz**
4013969

Tubería de lubricación forzada transmisión TWA 112/1135

DEUTZ

MV 1349

Tubería bajada de retorno bomba lineal

DEUTZ F5L913**MV 1352**

Tubería retorno de aceite del turbo

DEUTZ BF6L 913**MV 1368**

Flexible de aceite

DEUTZ F6L913**MV 1369**

Flexible lubricación de compresor

DEUTZ F6L913**MV 1369A**

Flexible lubricación de compresor

DEUTZ**MV 1369B**

Flexible lubricación de compresor

DEUTZ**MV 1369C**

Flexible lubricación de compresor

DEUTZ**MV 1372**

300mm + 97mm



Flexible remallada y rígida de lubricación de compresores

DEUTZ BF6M 1013RC EURO III - TATSA D12

MV 1369D

Flexible lubricación de compresor (Corto)

DEUTZ**MV 1391**

Flexible de aceite

DEUTZ F6L 913**MV 1401****Deutz**
4008181

Caño rígido para AX 5.65

DEUTZ**MV 1402****Deutz**
4008273

Caño rígido para AX 5.65

DEUTZ**MV 1403****Deutz**
4008275

Caño rígido para AX 5.65

DEUTZ**MV 1404****Deutz**
4008274

Conexión rígida retorno de dirección para AX 5.65

DEUTZ**MV 1405****Deutz**
4010914

Caño rígido retorno tramo 1 para AX 5.65

DEUTZ**MV 1406****Deutz**
4010477

Caño rígido de presión de dirección para AX 5.65

DEUTZ

MV 1413**Deutz**
4010307

Caño retorno tramo 1 para AX 5.80

DEUTZ**MV 1415****Deutz**
4008188

Caño rígido de presión de dirección para AX 5.80

DEUTZ**MV 1416**

Salida de bomba hidráulica

DEUTZ PUMA - TATSA D12 - BF6M 1013 FC
EURO III

MV 3510

Corto: 36cm

MV 3511

Largo: 48cm



Rigido salida de compresor

DEUTZ

MV 3581



Flexible salida de compresor

DEUTZ OA101 - EL DETALLE - BF6L913

MV 3582



Rigido salida de compresor

DEUTZ OA101

MV 3583



Rigido salida de compresor

DEUTZ OA101

MV 3611



Rigido salida de compresor

DEUTZ OA101

MV 3612



Rigido salida de compresor

DEUTZ OA101

MV 1345



Deutz
337 1888

Tubo protector de varilla levanta válvulas

DEUTZ 913 F2L - F3L - F4L - F5L - F6L

EX 4



Exhibidor para 4 caños

EX 5



Exhibidor de tuberías para 5 caños

EX 6



Exhibidor de tuberías para 6 caños

0222-0913

Ø M 14 x 1.5

Deutz
4231021 - 2100087
2134511 - 2239550
4150197 - 4157603
4167698
4230566**Ref. BCD:**
1662/7

Bomba de combustible para diesel

DEUTZ 913**0222-1100**

M 14 x 1.5

Deutz
245193100**Ref. BCD:**
2625

Bomba de combustible para diesel

SAME DEUTZ - FAHR GROUP INDUSTRIAL

Linea Deutz

Toberas

tmDLA285441	0433271201	Deutz L-2114-1114 - 0 431 204 045 KBL 112 5123/13
tmDLA285656	0433271322	Deutz F 8 L-413 USE 0 433 271 202 / 292 - 0 431 212 023 KBAL 65 S 13/18
tmDLA147P1229	0433171779	DEUTZ BM6L1013C
tmDLA147P658	0433171478	Deutz Station / 0 431 114 010 KBAL 101 P 67
tmDLA149S774	0433271376	Deutz DD-1000 S/turbo - 0 431 212 029 KBAL 65 S 13/13
tmDLA149S775	0433271377	Deutz DD-1000 C/turbo - 0 431 212 029 KBAL 65 S 13/13
tmDLA150P131	0433171119	Deutz motor BF 6 L 913 C / 0 431 113 987 KBEL 88 P 34

Elementos

em1418325138	1418325138	Deutz F 6 L-913 use 1 418 325 159
em1418325156	1418325156	Deutz F 8L 413 FL 413F use 1 418 325 103
em1418325156	1418325159	Deutz F6L 913 S/turbo use 1 418 325 138
em1418325162	1418325162	Deutz 849, 829, y 828 c/mot. F6L 913
em1418325163	1418325163	Deutz BF-6 L-913 C/turbo use 1 418 325 102
em1418421024	1418421024	Deutz L-2114 F2/F3/F4/F6

Valvulas

vm1418522011	1418522011	Deutz/Fahr Hanomag R45/55/65
vm1418522017	1418522017	Fiat 400/500/700/Deutz 1114 use 1 418 522 039
vm1418522018	1418522018	Deutz/Fahr Hanomag R45/55/65
vm1418522047	1418522047	Deutz 2114 Origen Alemania
vm1418522057	1418522057	Deutz BF 6 L-913 DD/1000
vm1418522201	1418522201	Mercedes Benz 1215 Mot.OM 366 p/bba. 9400084020 mot. Deutz estacionario
vm9418270040	9270-040	Tractor John Deere 4760 deutz el detalle



**DEUTZ**

A 30 F6L 714, FA 2/3/4/6		bm823L2
A 30 L 514-614-714-716		bm823L2
A6L 714, A8L 714		bm923L3
A10L 714, A12L 714		bm923L3
F6L 714, F8L 714, F10L 714		bm923L3
SA 8 L 714, SA 12 L 714		bm923L3
Tractor	F 1/2/3/6 M 517	bm511Z0
Tractor	F 1/2/4/6 L 712 - F 6/8	bm011A6

REPUESTOS

dmT-3LEP-A**Referencias 3LEP289**

52239702840

52239882840 **K27**

53279706407

53279886407 **H1E**

53279706409

53279886409

3580566

02232450

04157271

02919944

04157288

02913363

Lubricación

MV 1301

DEUTZ (KHD) BF6L913C

MTI 8302

Ø76x150



Agrale
6112001022000

Deutz
4024084

Fuelle de silicona para turbo

AGRALE MA15.0 / MA17.0 - DEUTZ

