

JAPONESSES



ISUZU

LÍNEA LIVIANA

Catálogo de productos



- Repuestos de inyección diesel.
- Bombas de combustible.
- Filtros trampa de agua.
- Toberas elementos y válvulas.
- Inyectores.
- Sensores.
- Tensores.
- Mangueras de intercooler.
- Turbos Sobrealimentadores.
- Cajas y flexibles levanta cabina.
- Tuberías rígidas y flexibles.





INDICE

INDICE
CON LINEAS
DE PRODUCTOS PARA
CATÁLOGOS POR MARCAS DE
VEHÍCULOS

1- Repuestos, Accesorios y Despiece para Inyección Diesel.

- Abrazaderas
- Anillos de Goma
- Arandelas
- Bombas Alimentadoras
- Bulones Perforados
- Mangueras Universales
- Cebadores
- Electroválvulas
- Filtros
- Juegos de Juntas
- Líquido aditivo Diesel Power
- Prefiltros
- Seguros para Caños de Inyección
- Uniones Orientables
- Válvulas
- Vasos

2- Toberas, elementos y válvulas "DMB" y toberas Common Rail e inyectores

3- Bujías Incandescentes "DMB".

4- Common Rail.

5- Tensores de correa.

6- Turbos "DMB"

7- Tuberías Flexibles y rígidas.

- Para Inyección
- Para Combustible
- Para Aceite
- Para Dirección Hidráulica
- Para Accionamiento de Embrague
- Para Freno Hidráulico
- Para Conducción de Agua y Aire
- Para Aire Comprimido



Guia explicativa uso de catalogo productos CMD.

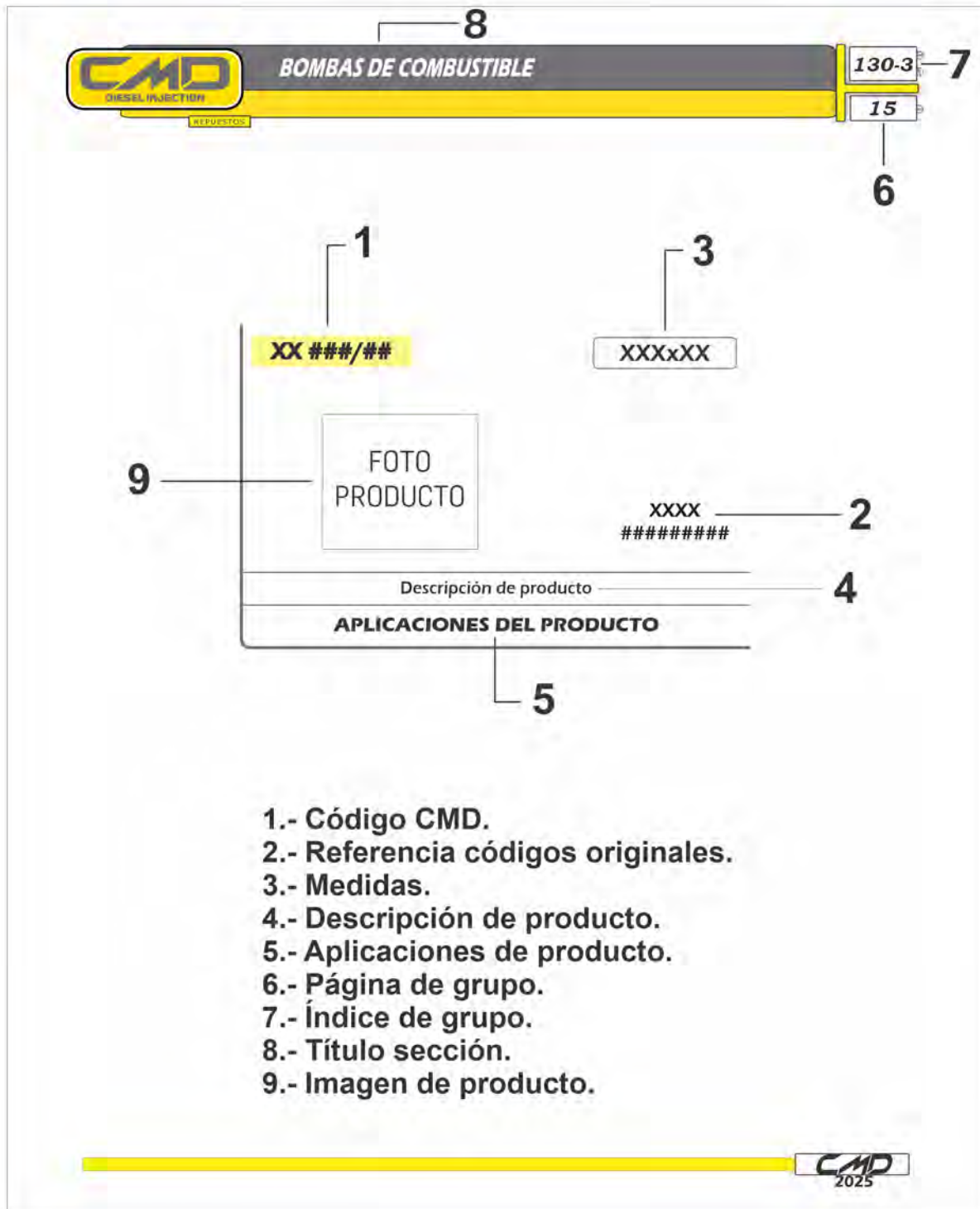

- 1.- Código CMD.
- 2.- Referencia códigos originales.
- 3.- Medidas.
- 4.- Descripción de producto.
- 5.- Aplicaciones de producto.
- 6.- Página de grupo.
- 7.- Índice de grupo.
- 8.- Título sección.
- 9.- Imagen de producto.

Las Marcas y Logos® que aparecen en los catalogos CMD pertenecen a sus respectivos dueños, y cuando son mencionadas estan a titulo informativo.

REPUESTOS

AH 104/1

Plana

NISSAN 175-205 / ISUZU 6BD1 / HINO

AH 104/5

Arandela buje

P/NISSAN 175-205 / ISUZU 6BD1 / HINO

REPUESTOS

CÓDIGO	MEDIDA (mm)		CÓDIGO	MEDIDA (mm)	
AL 105/1	4 x 9 x 1.25		AL 105/15A	19 x 23 x 1.25	
AL 105/2	5 x 9 x 1.25		AL 105/15B	18 x 25 x 1.25	
AL 105/2A	5 x 13 x 1.25		AL 105/16	20 x 26 x 1.25	
AL 105/3	6 x 10 x 1.25		AL 105/17	22 x 28 x 1.25	
AL 105/3A	7 x 10 x 1.25		AL 105/18	24 x 30 x 1.25	
AL 105/3B	7 x 14 x 1.25		AL 105/19	26 x 32 x 1.25	
AL 105/3C	7 x 14 x 2		AL 105/20	28 x 36 x 1.25	
AL 105/4	8 x 13 x 1.25		AL 105/21	30 x 36 x 1.25	
AL 105/5	8 x 12 x 1 (doble)		AL 105/22	32 x 40 x 1.25	
AL 105/6	9 x 14.5 x 1.25		AL 105/23	34 x 42 x 1.25	
AL 105/7	10 x 14.5 x 1.25		AL 105/23A	35 x 41 x 1.25	
AL 105/8	11 x 17 x 1.25		AL 105/24	36 x 42 x 1.25	
AL 105/9	12 x 17 x 1.25		AL 105/25	38 x 46 x 1.25	
AL 105/10	13 x 20 x 1.25		AL 105/25A	39.5 x 53 x 0.5	
AL 105/11	14 x 20 x 1.25		AL 105/26	41 x 45 x 1.25	
AL 105/11A	14 x 23 x 1.25		AL 105/26A	41 x 55 x 1.25	
AL 105/12	15 x 21 x 1.25		AL 105/26B	41 x 55 x 0.5	
AL 105/13	16 x 21 x 1.25		AL 105/27	42 x 49 x 1.25	
AL 105/13A	16 x 24 x 1.25		AL 105/28	44 x 52 x 1.25	
AL 105/14	17 x 22 x 1.25		AL 105/29	46 x 54 x 1.25	
AL 105/15	18 x 23 x 1.25		AL 105/30	52 x 60 x 1.25	

REPUESTOS

CÓDIGO	MEDIDA (mm)
CO 105/1	4 x 9 x 1.25
CO 105/2	5 x 9 x 1.25
CO 105/3	6 x 10 x 1.25
CO 105/3A	6 x 10 x 1 (doble)
CO 105/3B	7 x 14 x 1.25
CO 105/4	8 x 12.5 x 1.25
CO 105/4A	8 x 11 x 1.25
CO 105/5	8 x 12 x 1 (doble)
CO 105/6	9 x 14.5 x 1.25
CO 105/7	10 x 14 x 1.25
CO 105/8	11 x 17 x 1.25
CO 105/9	12 x 17 x 1.25
CO 105/10	13 x 20 x 1.25
CO 105/11	14 x 20 x 1.25
CO 105/11A	14 x 23 x 1.25
CO 105/12	15 x 21 x 1.25
CO 105/13	16 x 21 x 1.25
CO 105/13A	16 x 24 x 1.25
CO 105/14	17 x 22 x 1.25
CO 105/15	18 x 23 x 1.25
CO 105/16	20 x 26 x 1.25
CO 105/17	22 x 26 x 1.25
CO 105/18	24 x 30 x 1.25
CO 105/19	26 x 32 x 1.25
CO 105/20	28 x 36 x 1.25
CO 105/21	30 x 36 x 1.25
CO 105/22	32 x 40 x 1.25
CO 105/23	34 x 42 x 1.25
CO 105/24	36 x 42 x 1.25

CÓDIGO	MEDIDA (mm)
CO 105/25	38 x 46 x 1.25
CO 105/26	41 x 45 x 1.25
CO 105/27	42 x 49 x 1.25
CO 105/28	44 x 52 x 1.25
CO 105/29	46 x 54 x 1.25
CO 105/30	52 x 60 x 1.25



REPUESTOS

CÓDIGO	MEDIDA (mm)
FI 105/2	5 x 9 x 1.5
FI 105/2A	5 x 12 x 1.5
FI 105/3	6 x 10 x 1.5
FI 105/3A	6.5 x 12.5 x 1.5
FI 105/4	8 x 13 x 1.5
FI 105/6	9 x 14.5 x 1.5
FI 105/7	10 x 14 x 1.5
FI 105/8	11 x 17 x 1.5
FI 105/9	12 x 17 x 1.5
FI 105/10	13 x 20 x 1.5
FI 105/10A	13 x 24 x 1.5
FI 105/11	14 x 20 x 1.5
FI 105/12	15 x 21 x 1.5
FI 105/13	16 x 21 x 1.5
FI 105/13A	16 x 24 x 1.5
FI 105/14	17 x 22 x 1.5
FI 105/15	18 x 23 x 1.5
FI 105/16	20 x 26 x 1.5
FI 105/17	22 x 28 x 1.5
FI 105/18	24 x 30 x 1.5
FI 105/19	26 x 32 x 1.5
FI 105/20	28 x 36 x 1.5
FI 105/21	30 x 36 x 1.5
FI 105/22	32 x 40 x 1.5
FI 105/23	34 x 42 x 1.5
FI 105/24	36 x 42 x 1.5
FI 105/25	38 x 46 x 1.5
FI 105/26	41 x 45 x 1.5
FI 105/27	42 x 49 x 1.5

CÓDIGO	MEDIDA (mm)
FI 105/28	44 x 52 x 1.5
FI 105/29	46 x 54 x 1.5
FI 105/30	52 x 60 x 1.5



REPUESTOS

AC 112/45

15 x 21 x 3 mm



De cobre

TOYOTA

AH 112/48



8-9414.8392.2

De hierro, rompefuegos

INDENOR - CHEVROLET CORSA

AC 112/53



894420247-0

Cobreada

CHEVROLET CORSA CON MOTOR ISUZU

AC 112/53A



894420247-0

Pavonada

CHEVROLET CORSA CON MOTOR ISUZU

AC 112/55

7 x 14 x 4 mm



Cod.Orig.
620 411-3880
MED 16539

Asiento inyector

TOYOTA - ISUZU - KOMATSU

AC 112/56

7,2 x 14 x 4,7 mm



Cod.Orig.
16539

De Asiento inyector

ISUZU MEO

AC 112/57

7.3 x 15 x 6.5 mm



Isuzu
8-94125-3880

Asiento inyector

TOYOTA - ISUZU

AC 112/58

9.45 x 19 x 7.6 mm



Cod.Orig.
15315-0030
1205870

Asiento inyector

ISUZU

AC 112/59

7.2 x 17 x 2



Nipon Denso
11176-56030

De bronce

TOYOTA

AC 112/62

11x17x1.5



Para toberas PD y PDN

NISSAN - MITSUBISHI - TOYOTA - ISUZU

AH 112/63

11x17x2



Para toberas PD y PDN

NISSAN - MITSUBISHI - TOYOTA - ISUZU

AH 112/66

15,9 x 7,3 x 2



Toyota
11176-0L011
11176-30011

De hierro biselada asiento inyector common rail

TOYOTA HILUX COMMON RAIL 3.0 / 2.5

AH 112/67

15,9 x 7,3 x 3



Toyota
11176-0E010

De hierro biselada asiento inyector common rail

TOYOTA HILUX COMMON RAIL 2.4 / 2.8

AH 112/68

17 x 7,5 x 3,5



De hierro biselada asiento inyector common rail

TOYOTA COROLLA 2.0 D4D

REPUESTOS

AV 114/31



De cobre para válvula de bomba inyectora

MITSUBISHI CANTER

REPUESTOS

AL 115/5

12.5 x 22.2 x 1



De aluminio para retorno de inyector

TOYOTA

AL 115/6A

12.2 x 18.9 x 1



De aluminio para retorno de inyector

NISSAN

AC 115/97

8 x 13 x 1



Toyota
90904-30013
90430-T0008
Arandela doble retorno Common Rail Hilux 1-2KDFTV

TOYOTA

REPUESTOS

	Pulgadas		Milímetros	
	Ø min	Ø max	Ø min	Ø max
AB 117/1	5/16	3/8	8	10
AB 117/2	3/8	1/2	10	12
AB 117/2A	7/16	17/32	11	11.5
AB 117/3	1/2	9/16	12	14
AB 117/4	9/16	5/8	14	16.5
AB 117/5	11/16	3/4	17	19.5



Fleje ancho 9 mm - Espesor 0.5 mm

COMPACTA

	Pulgadas		Milímetros	
	Ø min	Ø max	Ø min	Ø max
AB 117/6	5/16	5/8	8	16
AB 117/7	3/8	13/16	10	20
AB 117/7A	1/2	1	12	26
AB 117/8	3/4	1 1/4	20	32
AB 117/9	1 1/4	1 3/4	30	45
AB 117/10	1 9/16	2 1/8	40	55
AB 117/11	2	2 9/16	50	65
AB 117/12	2 3/8	3	60	75

	Pulgadas		Milímetros	
	Ø min	Ø max	Ø min	Ø max
AB 117/13	2 3/4	3 3/8	70	85
AB 117/14	3 1/8	3 3/4	80	95
AB 117/15	3 1/2	4 1/8	90	105
AB 117/16	3 5/16	4 1/2	100	115
AB 117/17	4 5/16	4 15/16	110	125
AB 117/18	5 1/8	5 11/16	130	145



Fleje ancho 8.5 mm - Espesor 0.8 mm

MINI SUPER

REPUESTOS

	Pulgadas		Milímetros	
	Ø min	Ø max	Ø min	Ø max
AB 117/19	1 3/8	1 3/4	35	45
AB 117/20	1 9/16	2 1/8	40	55
AB 117/22	2 3/8	3	60	75
AB 117/23	2 3/4	3 3/8	70	85
AB 117/24	3 1/8	3 3/4	80	95
AB 117/25	3 1/2	4 1/4	90	105
AB 117/26	3 3/8	4 1/2	100	115

	Pulgadas		Milímetros	
	Ø min	Ø max	Ø min	Ø max
AB 117/27	4 5/16	4 15/16	110	125
AB 117/27A	4 3/4	5 3/8	120	135



Fleje ancho 14.4 mm - Espesor 0.8 mm

SUPER CIERRE RAPIDO

	Pulgadas		Milímetros	
	Ø min	Ø max	Ø min	Ø max
AB 117/29	9/16	3/4	14	20
AB 117/30	5/8	7/8	16	22
AB 117/31	3/4	1 1/8	20	28
AB 117/32	1	1 3/8	25	35
AB 117/33	1 3/16	1 9/16	30	40
AB 117/34	1 3/8	1 3/4	35	45
AB 117/34A	1 1/2	2	38	50
AB 117/35	1 9/16	2 1/8	40	55
AB 117/36	1 3/4	2 3/8	45	60

	Pulgadas		Milímetros	
	Ø min	Ø max	Ø min	Ø max
AB 117/37	2	2 5/8	50	65
AB 117/38	2 3/8	3	60	75
AB 117/39	2 3/4	3 3/8	70	85
AB 117/40	3 1/8	3 3/4	80	95
AB 117/41	3 1/2	4 1/8	90	105
AB 117/42	3 15/16	4 1/5	100	115
AB 117/43	4 5/16	4 15/16	110	125
AB 117/44	5 1/8	5 11/16	130	145



Fleje ancho 14.4 mm - Espesor 0.8 mm

TIPO AMERICANA

	Pulgadas		Milímetros	
	Ø min	Ø max	Ø min	Ø max
AB 117/90	1/4	5/8	6	16
AB 117/91	7/16	13/16	11	20
AB 117/92	1/2	15/16	13	24



Fleje ancho 8 mm - Espesor 0.5 mm

REPUESTOS

	Pulgadas	
	Ø min	Ø max
AB 117/45	9	11
AB 117/46	11	13
AB 117/47	13	15
AB 117/48	15	17
AB 117/49	17	19
AB 117/50	19	21
AB 117/51	21	23
AB 117/52	23	25
AB 117/53	25	27
AB 117/54	27	29
AB 117/55	29	31
AB 117/56	31	33
AB 117/57	33	35
AB 117/58	35	37
AB 117/59	37	41
AB 117/60	41	44
AB 117/61	44	47
AB 117/62	47	50
AB 117/63	50	54
AB 117/64	54	58
AB 117/65	58	62
AB 117/66	62	66



**SOPORTAN ALTAS PRESIONES, REUTILIZABLES, CIERRE PERFECTO.
SOPORTAN ALTAS TEMPERATURAS, ANTICORROSIVAS, ATÓXICAS.
ECONOMÍA DE COSTO, FACILIDAD DE COLOCACIÓN.**

PI 161/101



Para abrazaderas plásticas
VS

REPUESTOS

AG 122/68



Para bomba EP/VE Nippon Denso
ISUZU - TOYOTA - NISSAN

AG 122/69



Para bomba EP/VE Nippon Denso
ISUZU - TOYOTA - NISSAN

AG 122/69A



Para bomba EP/VE Nippon Denso
ISUZU - TOYOTA - NISSAN

REPUESTOS

AG 122/69B



Para bomba EP/VE Nippon Denso
ISUZU - TOYOTA - NISSAN

REPUESTOS

BR 125/17A



Antillama
NISSAN

REPUESTOS

BA 130/23



Bosch
0 440 003 177
0 440 003 185
0 440 003 190
9 440 030 001
0 440 003 178
0 440 003 180
Mercedes Benz
001 091 15 01
001 091 73 01
001 091 27 01
002 091 60 01
Hino
EH700

Fiat
8122111
8122177
1247478
KHD
01287476
01287480
01521721310
01521721320
03366125
FP/KE 22 AD 240/2
FP/KE 22 AD 247/2
FP/KE 22 AD 223/2
FP/KE 22 AD 218/2
FP/KE 22 AD 241/2
FP/KE 22 AD 198/2

Bomba alimentadora con cuerpo de fundición

KHD - MTU - HINO

BA 130/44



Bosch
9440030030
0440004072
0440004073
0440004074
MWM
605202000021
FP/KSG 22 AD 45/2

Bomba alimentadora con perno

HINO W04 D/VS

BA 130/45



Bosch
0 440 004 071
0 440 004 996
Mercedes Benz
003 091 72 01
000 090 0450
000 090 11 50
MWM Diesel
905202000032
FP/KEG 22 AD 281/2
FP/KSG 22 AD 23/2
FP/KS 22 AD 23/2

KHD/Deutz
3353174
Magirus Deutz
93190098
Fiat Allis
75204059
Iveco
93190098

Bomba alimentadora con perno

KHD - YAN-MAR - VS

BA 130/68



Zexel
0921001900

Bomba alimentadora

PARA BOMBA INYECTORA NIPPON DENSO

BA 130/73



Zexel
1052101800
1052104250
1052104251
1052104280 (FP/KE-A)
1052104931
1052104261
1052105510
1052101140
Toyota
3B/13B
EH100/6D22

Isuzu
DA120 / DH100
Mitsubishi
8DC/40-60-6D20/22
Komatsu
6D105

Bomba alimentadora

ISUZU - KOMATSU - TOYOTA - FUSO MITSUBISHI

BA 130/74



Zexel
1052174000
1052171580 (FP/KE-P)
1052171730
1052171480
1052171200

Bomba alimentadora

HINO EK 100 - NISSAN RD6 Y RD8 MITSUBISHI 8DCD8 Y 8DC9

BA 130/75



Bosch
9440610008
Zexel
0921000402
0921000971
1052104630
Isuzu
8-9413-1013-0

Bomba alimentadora

TOYOTA DYNA 2J0402/TICO INDUSTRIAL (AUTOELEVADORES)
TOYOTA LAND CRUISER 2H0971/2HT-0971 - MITSUBISHI - ISUZU

BA 130/76



Zexel
105220 1720
105220 1871
105220 1860
105220 1800
105220 1880
105220 5001
NP/FP/KS 22 AC
47/1 NP11

Bomba alimentadora

HINO CANTER - NISSAN SD22 /SD23 MITSUBISHI 4D30 / 4D31 - KOMATSU 6D95L DAIHATSU ENGINE B/3B/13B/DG

BA 130/77



Zexel
105220-1570
105220-1590
105220-1591
105220-5251
105220-4742
105220-1070
105220-4561
105220-4781

NP/FP/KS 22 AC

Bomba alimentadora

ISUZU C190/C240/6BD1/D500/6BB1 PD 6BB1 LK / 6BB1 LF - HITACHI - BEDFORD

REPUESTOS

BA 130/78



Zexel
105220-7060
105220-7180

Bomba alimentadora con perno

VS

BA 130/79



Zexel
105220-7010

Bomba alimentadora con perno

VS

BA 130/80



Zexel
092100 0942
092100 1490
105210 1941
105210 1351
105210 4151

ND-FP/KE22A
CND 094

Bomba alimentadora

VS

BA 130/81



Zexel
105220-5690

Bomba alimentadora

VS

BA 130/82



Zexel
105207 1041

Bomba alimentadora

VS

BA 130/88



Zexel
105210-6370

Bomba alimentadora

ZEXEL - NIPPON DENSO

0233-2032



Kubota
KU0205-039005
16285-52032
16285-52030

KUBOTA V1035/V1105/D905/D1005

REPUESTOS

CM 133/4



Lucas/Delphi
9001-090A

Para filtro trampa de agua. Paso grueso

INDENOR

CM 133/5



TOYOTA HILUX

CM 133/6



Lucas/Delphi
9001-090B

Para filtro - Paso fino

INDENOR XD2

REPUESTOS

CM 133/10



Lucas/Delphi
9001-088A

Entrada y salida recta de 8 x 8 mm

VS

CM 133/11



Lucas/Delphi
9001-088/10

Entrada y salida recta de 10 x 10

VS

CM 133/12



Entrada con unión de 14 mm y salida recta de 8mm

VS

REPUESTOS

CM 133/15



Lucas/Delphi
9001-298

Entrada recta de 8 x 8 mm y salida en ángulo de 90°

VS

REPUESTOS

- CF 138/1** 5 x 9 mm
- CF 138/2** 8 x 12 mm
- CF 138/3** 9,5 x 14 mm
- CF 138/7** 6 x 10 mm
- CF 138/8** 13 x 18 mm
- CF 138/9** 16 x 24 mm



En rollo de 10 metros

REPUESTOS

- CC 138/20** 3 x 6 mm
- CC 138/22** 4 x 7 mm
- CC 138/23** 4 x 8 mm
- CC 138/24** 6 x 10 mm
- CC 138/25** 6 x 11 mm
- CC 138/26** 6 x 12 mm
- CC 138/27** 7 x 12 mm
- CC 138/28** 7 x 14 mm
- CC 138/29** 8 x 12 mm
- CC 138/30** 8 x 14 mm
- CC 138/31** 9 x 16 mm



En rollo de 50 metros

REPUESTOS

CH 138/35	3 x 6 mm
CH 138/36	4 x 7 mm
CH 138/37	4 x 8 mm
CH 138/38	6 x 10 mm
CH 138/39	6 x 12 mm
CH 138/40	7 x 11 mm
CH 138/41	7 x 12 mm
CH 138/42	7 x 14 mm
CH 138/43	8 x 14 mm
CH 138/44	9 x 6 mm



En rollo de 50 metros

REPUESTOS

CP 138/50	4 x 6 mm	Retorno de combustible
CP 138/51	6 x 8 mm	Lubricación de aceite
CP 138/52	7 x 10 mm	Combustible
CP 138/53	8 x 11 mm	Aire y Combustible
CP 138/54	9 x 12 mm	Aire
CP 138/54A	11 x 14 mm	Aire
CP 138/55	12 x 16 mm	
CP 138/55B	14 x 18 mm	
CP 138/56	Ø Int 1/4"	
CP 138/57	Ø Int 3/8"	
CP 138/58	Ø Int 1/2"	
CP 138/59	Ø Int 5/8"	



En rollo de 50 metros

REPUESTOS

CT 138/63	3 x 7 mm
CT 138/64	4 x 8 mm
CT 138/65	5 x 9,5 mm
CT 138/66	6 x 12 mm
CT 138/67	7 x 12 mm
CT 138/68	8 x 13 mm
CT 138/69	9 x 15 mm

En rollo de 50 metros

En rollo de 25 metros



REPUESTOS

CG 138/70 3 x 7 mm

CG 138/70A 4 x 8 mm

CG 138/70B 5,5 x 9 mm

CG 138/70C 6 x 12 mm

CG 138/70D 8 x 13 mm



En rollo de 50 metros



REPUESTOS

DI 143/7



Bosch
EPME 17S6Z
Nipon Denso
090 580-0022
090 580-0011

Diafragma

RASTROJERO 42 HP / TOYOTA JK

DI 143/12



Fiat
753 183

Diafragma

N. DENSO DAIHATSU

DI 143/14



Fiat
747 232

Diafragma

TOYOTA

DI 143/14C



Nipon Denso
090 580 0041
Zexel
155020-8420
155020-8620

Diafragma

**TOYOTA BV-3B / DAIHATSU
DIESEL KIKI**



REPUESTOS

FC 151/22



Trampa de agua universal con elemento filtrante y vaso cónico

VS ETC

FC 151/23A



Cod. Original
23300-64430

Filtro trampa de agua

TOYOTA

FC 151/23B



Cod. Original
23301-87309

Filtro trampa de agua

TOYOTA

REPUESTOS

FC 151/23C



Hyundai
31970-44500
31972-44000
Mitsubishi
MB220900
MB554592
MB552233
MB5549550

Filtro de combustible trampa de agua

MITSUBISHI L200

HYUNDAI H1/STAREX/GALLOPER 2.5TD

FC 151/27



Trampa de agua c/cebador univ. y filtro unidad sellada con purgador

UNIVERSAL

FC 151/60



Hyundai
31920-66200
31920-66200PL3

Filtro de combustible plástico, trampa de agua

HYUNDAI HD45/HD65 D4AF

REPUESTOS

JR 155/91A/AC



ACERO REFORZADO

De bba. P. contiene 4 laminas, 4 bujes, y 4 arandelas planas.

MOTOR NISSAN 175/205 - ISUZU 6BD1

JR 155/91B/AC



ACERO REFORZADO

De bba. P. contiene 5 laminas, 4 bujes, y 4 arandelas planas.

HINO (TODOS)

JR 155/106

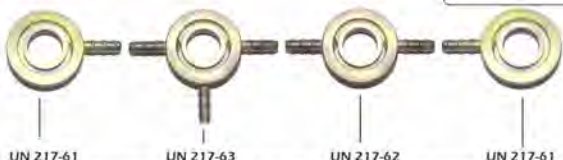

UN 217-61

UN 217-63

UN 217-62

UN 217-61

Kit de uniones rebase de inyectores ϕ 28mm

TOYOTA 2.0 Y 2.4 - NISSAN - KIA BESTA 2.2

JR 155/107

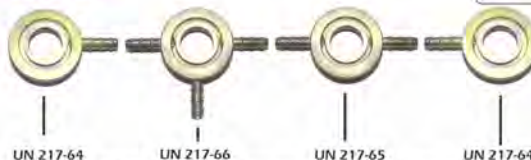

UN 217-64

UN 217-66

UN 217-65

UN 217-64

Kit de uniones rebase de inyectores ϕ 24mm

TOYOTA 2.0 Y 2.4 - NISSAN - KIA BESTA 2.2

JR 155/108



UN 217-67

UN 217-68

UN 217-68

UN 217-69

Kit de uniones rebase de inyectores ϕ 24mm

CHEVROLET CORSA CON MOTOR ISUZU 1.7

JR 155/108A



UN 217/67

UN 217/66A

UN 217/68

UN 217/67

ϕ 24mm

Kit de uniones rebase de inyectores

CHEVROLET CORSA MOTOR ISUZU 1.7

REPUESTOS

JR 155/155

- CP 134/1A
- CP 134/2A
- AC 115/53
- AL 115/64
- AG 122/60
- AG 122/65
- AG 122/58
- AG 122/51
- AG 122/66
- AG 122/52
- AG 122/67
- AG 122/57
- AG 122/59

- AP 104/40B
- AG 122/55

Ref. Original
Bosch
1 467 010 520

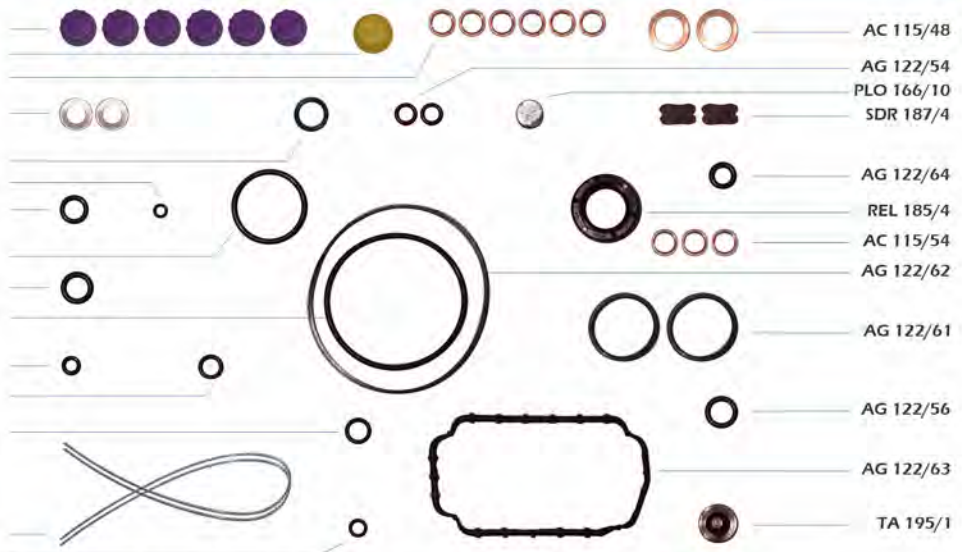

Juego de junta para bomba Bosch EP/VE + Reten REL 185/4 (20x31x7)

VS

JR 155/156

- CP 134/1A
- AC 115/53
- AL 115/64
- AG 122/60
- AG 122/65
- AG 122/53
- AG 122/52
- AG 122/57
- AG 122/59

- AP 104/40B
- AG 122/55

Ref. Original
Bosch
9 461 080 509

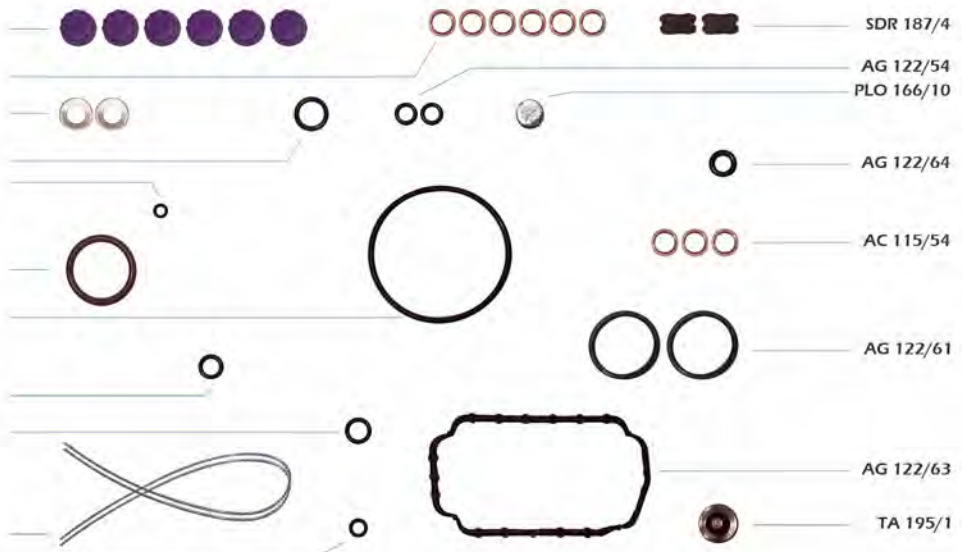

Juego de junta para bomba Bosch EP/VE

VS

JR 155/157

- CP 134/1A
- AC 115/53
- AL 115/64
- AG 122/57
- AG 122/60
- CP 134/2A
- AG 122/51
- AG 122/52
- JUN 156/27
- AG 122/59

- AP 104/40B
- AG 122/55

Ref. Original
Bosch
9 461 610 430
Nipon Denso
146600-2420

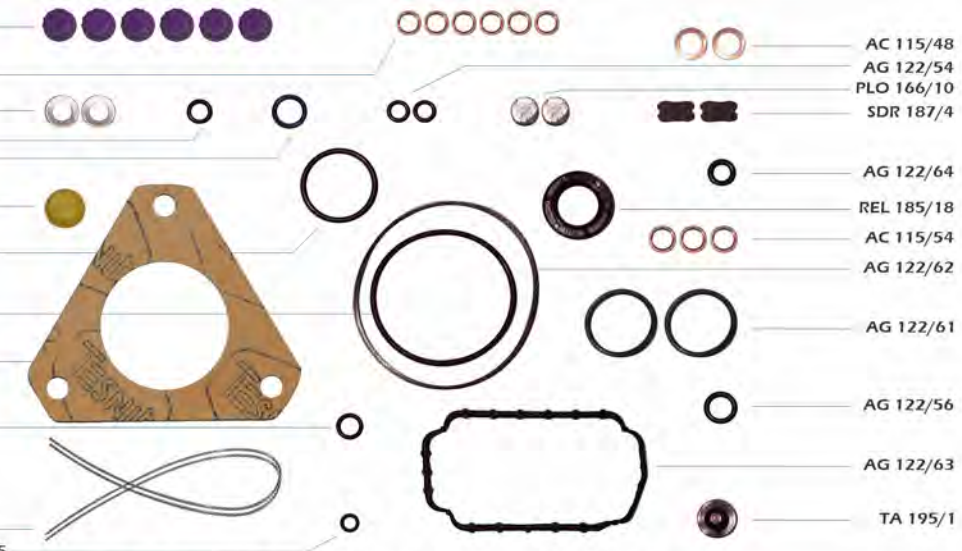

Juego de junta para bomba Bosch EP/VE con TPS + Reten REL 185/18 (20x30x7)

DK - EP/VE.....F - MAZDA - NISSAN

REPUESTOS

JR 155/157A

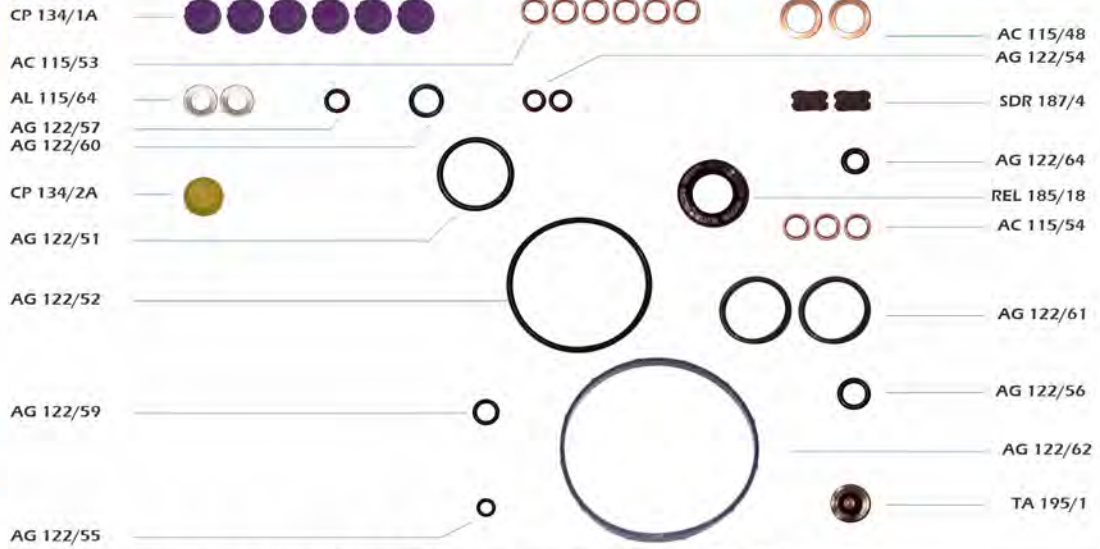

Ref. Original
Bosch
9 461 610 430
Nipon Denso
146600-2420

Juego de junta para bomba Bosch EP/VE + Reten REL 185/18 (20x30x7)

DK - EP/VE.....F - MAZDA - NISSAN

JR 155/157B

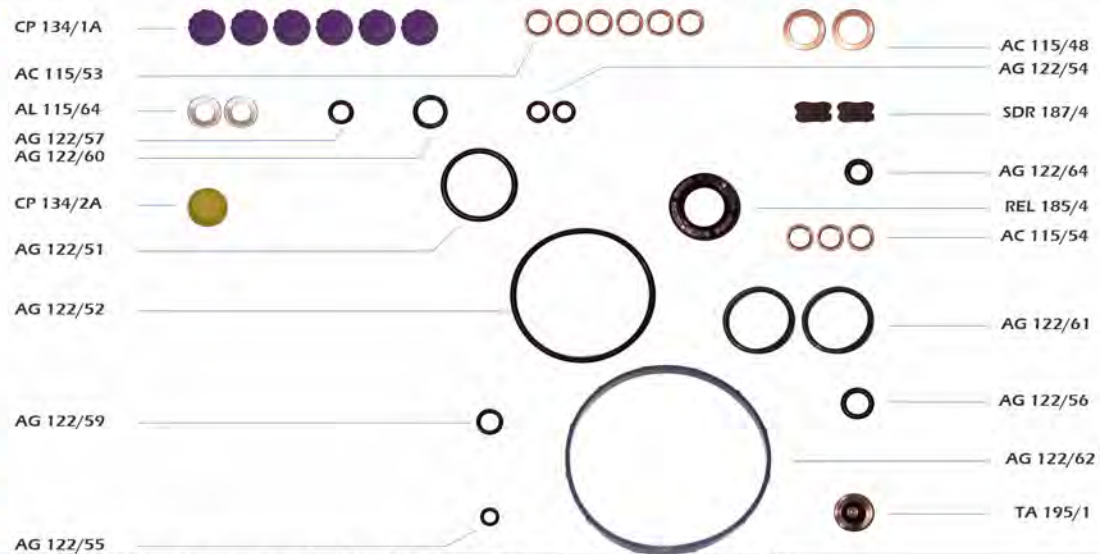

Ref. Original
Bosch
9 461 610 430
Nipon Denso
146600-2420

Juego de junta para bomba Bosch EP/VE + Reten REL 185/4 (20x31x7)

DK - EP/VE.....F - MAZDA - NISSAN

JR 155/157C

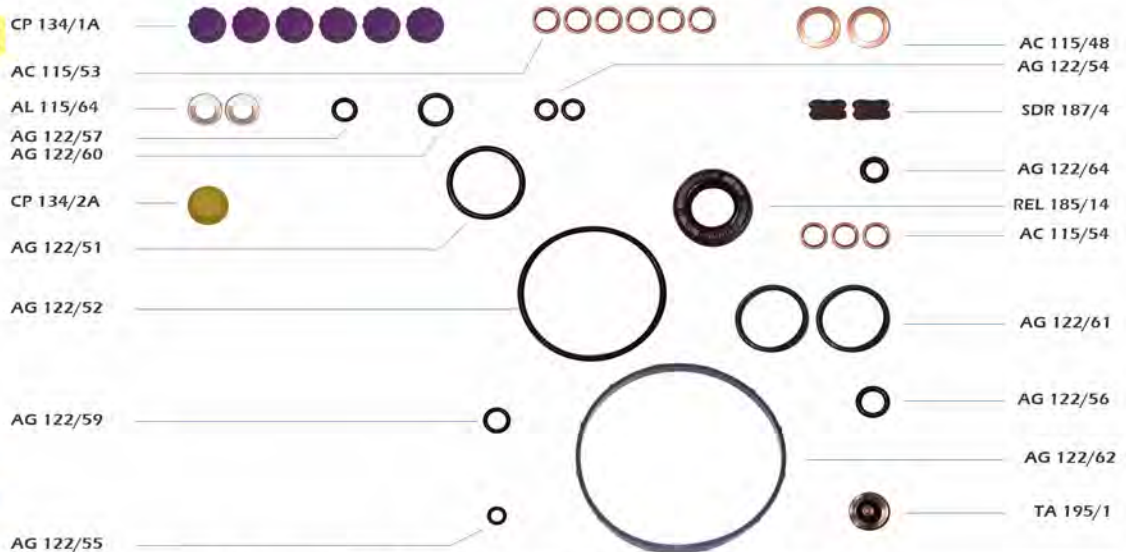

Ref. Original
Bosch
9 461 610 430
Nipon Denso
146600-2420

Juego de junta para bomba Bosch EP/VE + Reten REL 185/14 (17x28x7)

DK - EP/VE.....F - MAZDA - NISSAN

REPUESTOS

JR 155/158



Ref. Original
Nipon Denso
146600-11205

Juego de junta para bomba Bosch EP/VE + Reten REL 185/18 (20x30x7)

VS

JR 155/159

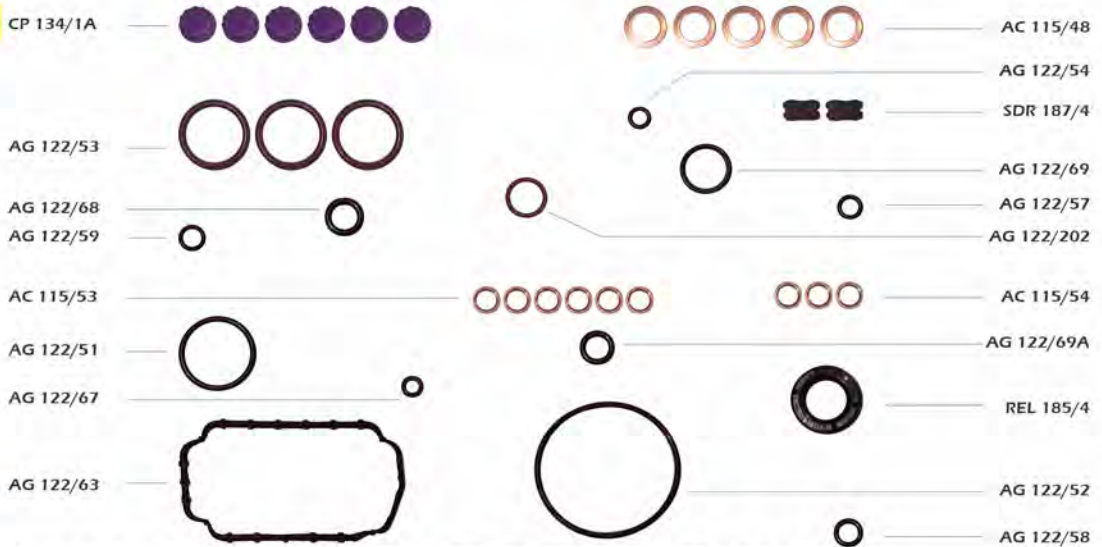

Ref. Original
Nipon Denso
0906-0112

Juego de junta para bomba Nipon Denso EP/VE + Reten REL 185/4 (20x31x7)

VS

JR 155/160

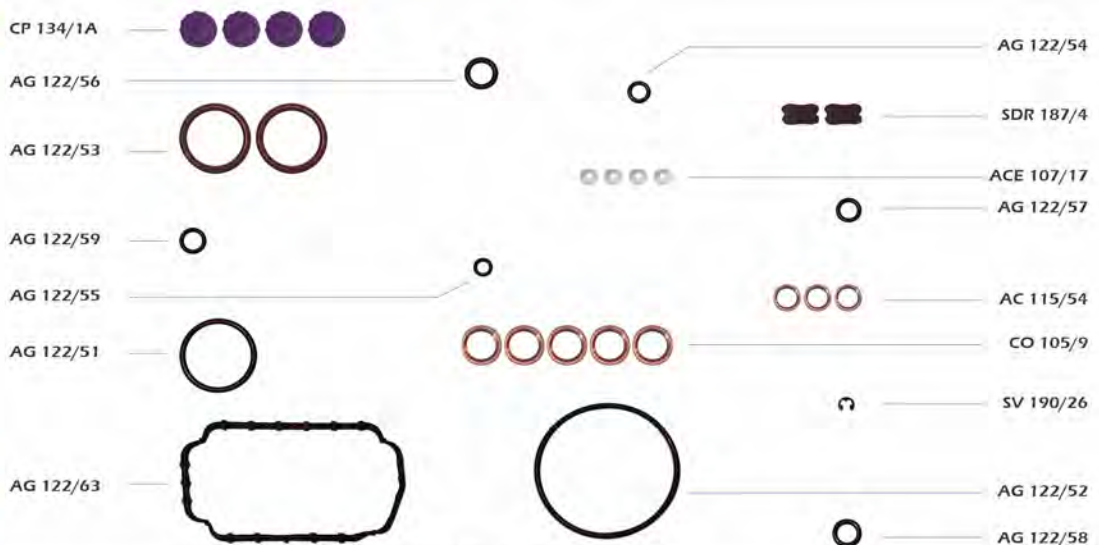

Ref. Original
Nipon Denso
090610-0010

Juego de junta para bomba Nipon Denso EP/VE

VS

REPUESTOS

JR 155/161

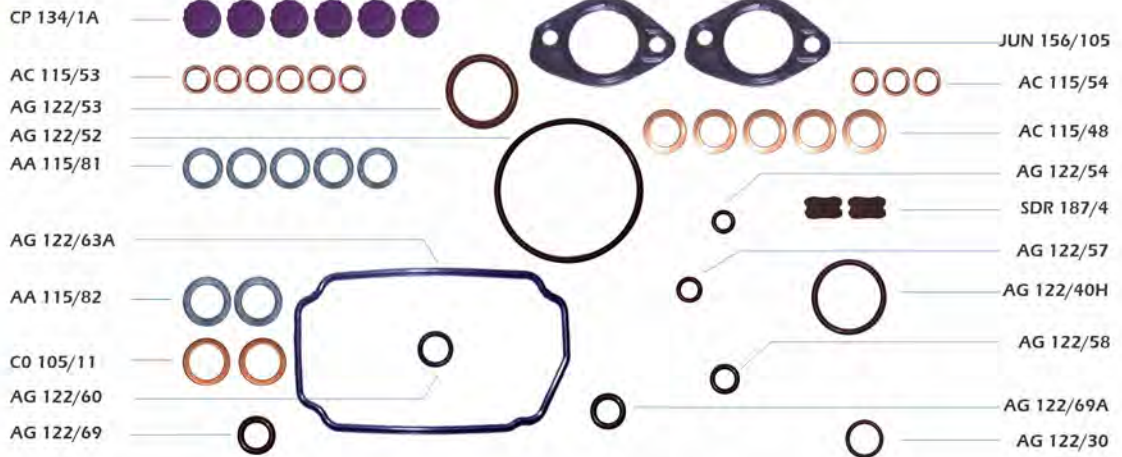

Ref. Original
 Nipon Denso
 146600-6320
 Bosch
 9461628160

Juego de junta para bomba Zexel EP/VE
VS

REPUESTOS

JR 155/301H

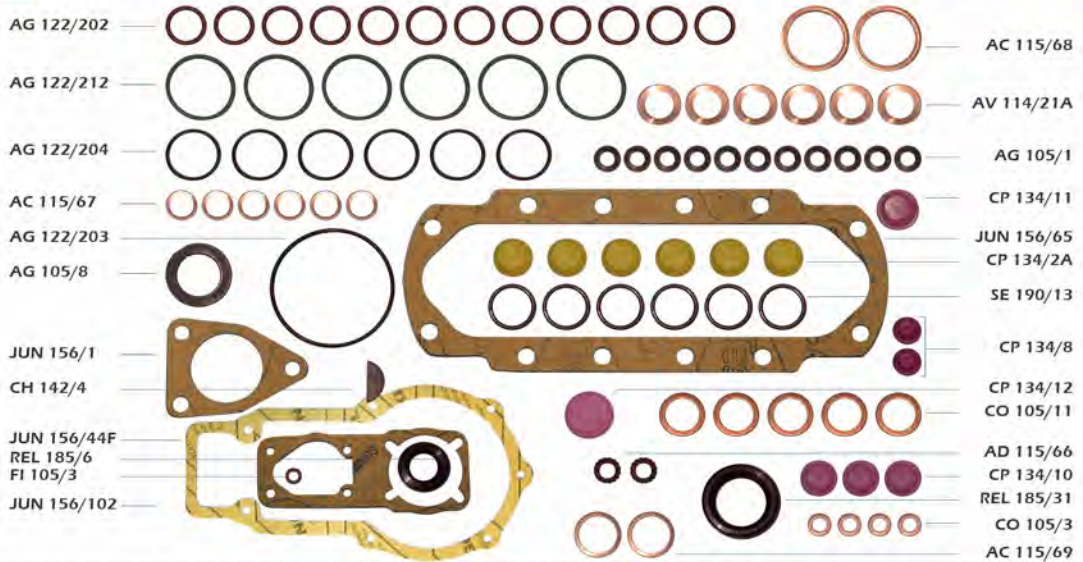

Juego de junta para bomba tipo P + Reten REL 185/31 (29x41x7)
HINO

REPUESTOS

JUN 156/44F



Cod. Orig
 90133200

Junta para gobernador bomba inyectora

MOTOR HINO

JUN 156/44G



Junta para gobernador bomba inyectora

MOTOR ISUZU - NISSAN 175-180 (4 Y 6 cil)

JUN 156/105



Bosch
 1461074328

De avance para bomba Bosch EP/VE

FORD TRANSIT

REPUESTOS

LA 158/4
COMUN

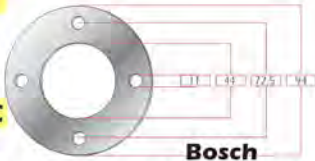

LA 158/4/AC
ACERO
REFORZADO

Bosch
1 410 136 005

Lamina de acople

SCANIA VABIS - CHEVROLET 350 - DEUTZ
MOTOR NISSAN 165/205 - ISUZU 6BD1 - HINO

REPUESTOS

MIA 159/101



Trazo 1/8" - Color amarillo

Contenido Neto **60** cm3

Para marcar, numerar y codificar todo tipo de metales plásticos, maderas, gomas, cerámicas, etc. Escribe inclusive sobre superficies aceitosas y rústicas, resiste temperatura e intemperie. Provisto en envase de plástico, flexible, anatómico.

MARCADOR INDUSTRIAL - PINTURA PARA PRECINTO

REPUESTOS

PE 162/26BI



Bosch
9 461 616 128
Zexel
146210-5720

Pernos, bujes y rodillos de bomba tipo EP/VE

VS

PE 162/26CI



Bosch
1 467 010 535

Pernos, bujes y rodillos de bomba tipo EP/VE

VS

PE 162/26BIG



GRAFITADOS

Bosch
9461616128
Zexel
146210-5720

Pernos, bujes y rodillos de bomba tipo EP/VE

VS

PE 162/26CIG



GRAFITADOS

Bosch
1467010535

Pernos, bujes y rodillos de bomba tipo EP/VE

VS

PE 162/26H



10 x 41,3
GRAFITADOS

Bosch
9441610203
Zexel
152030-0300

Perno impulsor p/bomba alimentadora tipo Zexel

VS

REPUESTOS

PT 170/41

Portatovera
ISUZU 4-6 CILINDROS
DN0SD193 - DN0SD177

PT 170/42

Portatovera
NISSAN 4-6 CILINDROS
DN0SD193

PT 170/43

Portatovera
TOYOTA 4-6 CILINDROS
DN4SD90

PT 170/49

Portatovera para bomba rotativa
ISUZU
154PN116

PT 170/50

Cod. Orig.
150601-4201Portatovera
ISUZU
DN0SD193NP1

PT 170/63

Portatovera
MITSUBISHI - NISSAN - TOYOTA
DN4PD57

PT 170/75

Portatovera
MITSUBISHI L200 / MONTERO
DN0PDN112

PT 170/76

Portatovera
NISSAN - MAZDA
DN0PDN127

PT 170/78

Portatovera
ISUZU 3.1
DN0PDN127

PT 170/86

Portatovera
TOYOTA HILUX - 1KD FTV 3.0 / 2KD FTV2
DENSO

PT 170/90

Portatovera
NISSAN PE6
PASO FINO

PT 170/91

Portatovera
NISSAN 175 - FD6 Y FD6 TURBO
PASO GRUESO

PT 170/92

Portatovera
NISSAN 175 - FD6 Y FD6 TURBO
PASO FINO

PT 170/99

Bosch
9 431 610 363
Zexel
150650-7500Portatovera
NISSAN

REPUESTOS

REL 185/3V

20x31x4/7



Para bomba EP/VE "duo" - Reforma de Viton - Doble labio para alta presión

NISSAN - ISUZU

REL 185/4

20x31x7



Bosch
2 460 283 001

De bomba EP/VE con cono de 20mm y guardapolvo

VS

REL 185/14

17x28x7



Bosch
1 460 283 301
2 916 730 057

De bomba EP/VE con guardapolvo

VS

REL 185/18

20x30x7



Bosch
1 410 281 012
2 916 730 059

De bomba EP/VE con guardapolvo

VS

REL 185/31

29x41x7



Reten para bomba P con motor Hino

VS

REPUESTOS

SDR 187/7



Zexel
091337-0150
Toyota
22723-68150

Para regulador

MITSUBISHI - TOYOTA

REPUESTOS

SO 191/9

12 Volts



Nipon Denso
096010-0500
096030-0160
096030-0070

Bomba EP/VE - Nipon Denso - Zexel

TOYOTA HILUX - VS

SO 191/10

24 Volts



Nipon Denso
096030-0080
Zexel
146850-1320

Bomba EP/VE - Nipon Denso - Zexel

VS

REPUESTOS

TV 194/17A

M20 x 1.5



Tapa de filtro vertical con boton

TOYOTA HILUX

TV 194/17G

UNF 3/4" x 16 TPI



Tapa de filtro vertical con boton

TOYOTA

TV 194/17L

UNF 3/4" x 16 TPI



Cod. Orig.
23300-64430

Tapa de filtro con boton

TOYOTA

TV 194/17M

M20 x 1.5



Cod. Orig.
23301-87309

Tapa de filtro con boton

TOYOTA

TV 194/17N

3/4" X 16 UNF - E/S=8mm



Nissan
16400-44G10
JapanParts
DH010

Tapa de filtro con botón pulsador

NISSAN PATROL 2.8 - TERRANO/PATHFINDER 2.7
CABSTAR 2.5/3.0

TV 194/17P

R = 3/4"x16UNF



Toyota
23300-64320
23301-17050

Tapa de filtro con boton

TOYOTA

TV 194/17T

R = M20 x 1.5



Hyundai
31975-44000
31972-44000
31972-44100
Mitsubishi
129677

Tapa de filtro con boton pulsador

MITSUBISHI L300 - HYUNDAI - NISSAN

TV 194/17Y



Toyota
23301-64010
23301-54560
23301-54460
23301-67010
23301-17060

Tapa de filtro con botón pulsador

TOYOTA HILUX

REPUESTOS

UN 217/61

Ø28mm



Para rebase de inyectores 1 salida

CHEVROLET - NISSAN - TOYOTA

UN 217/62

Ø28mm



Para rebase de inyectores 2 salidas

CHEVROLET - NISSAN - TOYOTA

UN 217/63

Ø28mm



Para rebase de inyectores 3 salidas

CHEVROLET - NISSAN - TOYOTA

UN 217/64

Ø24mm



Para rebase de inyectores 1 salida

CHEVROLET - NISSAN - TOYOTA

UN 217/65

Ø24mm



Para rebase de inyectores 2 salidas

CHEVROLET - NISSAN - TOYOTA

UN 217/66

Ø24mm



Para rebase de inyectores 3 salidas

CHEVROLET - NISSAN - TOYOTA

REPUESTOS

UN 217/66A

Ø24mm



Unión de hierro disco de 3 salidas

CHEVROLET CORSA MOTOR ISUZU 1.7

UN 217/67

Ø24mm



Para rebase de inyectores 1 salida

CHEVROLET CORSA CON MOTOR ISUZU 1.7

UN 217/68

Ø24mm



Para rebase de inyectores 2 salidas

CHEVROLET CORSA CON MOTOR ISUZU 1.7

UN 217/69

Ø24mm



Para rebase de inyectores 2 salidas

CHEVROLET CORSA CON MOTOR ISUZU 1.7

REPUESTOS

UC 218/PE06

Para Poliamida de 6 mm

UC 218/PE08

Para Poliamida de 8 mm

UC 218/PE10

Para Poliamida de 10 mm

UC 218/PE12

Para Poliamida de 12 mm

UC 218/PE14

Para Poliamida de 14 mm

UC 218/PE16

Para Poliamida de 16 mm

UC 218/PE1/4

Para Poliamida de 1/4"

UC 218/PE3/8

Para Poliamida de 3/8"

UC 218/PE1/2

Para Poliamida de 1/2"

UC 218/PE5/16

Para Poliamida de 5/16"



Union Conectora para Poliamida
(TEE - Tubo - Tubo) Modelo PE

VS

REPUESTOS

- UC 218/PU06** Para Poliamida de 6 mm
- UC 218/PU08** Para Poliamida de 8 mm
- UC 218/PU10** Para Poliamida de 10 mm
- UC 218/PU12** Para Poliamida de 12 mm
- UC 218/PU14** Para Poliamida de 14 mm
- UC 218/PU16** Para Poliamida de 16 mm
- UC 218/PU1/4** Para Poliamida de 1/4"
- UC 218/PU3/8** Para Poliamida de 3/8"
- UC 218/PU1/2** Para Poliamida de 1/2"
- UC 218/PU5/16** Para Poliamida de 5/16"

 Union Conectora para Poliamida
(Tubo - Tubo) Modelo PU

VS

- UC 218/PV04** Para Poliamida de 4 mm
- UC 218/PV06** Para Poliamida de 6 mm
- UC 218/PV08** Para Poliamida de 8 mm
- UC 218/PV10** Para Poliamida de 10 mm
- UC 218/PV12** Para Poliamida de 12 mm
- UC 218/PV1/4** Para Poliamida de 1/4"
- UC 218/PV3/8** Para Poliamida de 3/8"
- UC 218/PV1/2** Para Poliamida de 1/2"
- UC 218/PV5/16** Para Poliamida de 5/16"



Union Conectora para Poliamida (Tubo - 90°) Modelo Pv

VS

REPUESTOS

VAL 221/2 14 x 1.5



Bosch
1 457 413 010

Válvula

VS

VAL 221/3 12 x 1.5



Bosch
1 417 413 012

Válvula

VS

VAL 221/6 14 x 1.5



Bosch
1 417 413 000

Válvula

VS

REPUESTOS

VAL 221/17

14 x 1.5

Bosch
1 417 413 047

Válvula

MERCEDES BENZ 1114
VAL 221/18

8 mm



Válvula anti-retorno de entrada y salida recta

VS
VAL 221/22

6 mm



Válvula anti-retorno de entrada y salida recta

VS
VAL 221/19A

10 mm



Válvula anti-retorno de entrada y salida recta

VS
VAL 221/19B

12 mm



Válvula anti-retorno de entrada y salida recta

VS
VAL 221/32

14 x 1.5

Zexel
134424-0820

Válvula para bomba inyectora

HINO
VAL 221/46

Bosch
1110010013
Cummins
4938005
Isuzu
8973716180
Ford
6C469H31AA

Válvula limitadora de presión para rampa common rail

MITSUBISHI CANTER 3.0L

REPUESTOS

TOBERAS

tmDN0SD177	9432610021	Isuzu 4FB1
tmDLLA143PN265	9432610603	ISUZU NPR TURBO
tmDLLA146PN055	105017-0550	Isuzu 2.8 D
tmDLLA153PN177	9432610452	Isuzu
tmDLLA154PN061	9432610283	ISUZU 4BE1
tmDLLA154PN064	9432610280	ISUZU -4BG1-6BG1 -KIA
tmDLLA154PN116	9432610289	Chevrolet LUV 2.5 Isuzu 4JA1
tmDLLA154PN186	105017-1860	Isuzu 4HF1
tmDLLA158PN209	9432610377	Isuzu LUV 2.5
tmDN0SD2110	0434250012 105000-1650	Isuzu 2.8 TDL /D - Mercedes Benz - inyector completo
tmLA154S304N474	9432610025 105015-4740	Isuzu
tmLA154S324N413	9432610018	ISUZU 6BD1 SENCILLO
tmLA154S334N419	9432610024	ISUZU 6BD1 TURBO



REPUESTOS

TOBERAS

tmDLLA160PN004	9432610168	Mitsubishi 4D31T
tmDLLA160PN036	9432610227	Mitsubishi 4D31T
tmDN10PDN130	9432610295	Mitsubishi Montero
tmDN10PDN129	9432610294	Mitsubishi Montero



REPUESTOS

TOBERAS

tmDN0PDN113	9432610077	Nissan 4D56 - Td23 - Mitsubishi
tmLA155S334NP96	9432610241	NISSAN SENCILLO
tmDN0PDN121	9432610199	Nissan Td27
tmLA166S374NP6	9432610015	Nissan Tk20



REPUESTOS

TOBERAS

tmDN4PD1	9432610429/221	Daihatsu-Toyota B
tmDN4SD24NP80		Toyota-Daihatsu
tmDN4PD57	9432610284	Toyota Hilux Motor 3L
tmDN20PD32	9432610436	Toyota 6 cilindros
tmDN0PD58	093400-5581	Toyota
tmDLLA150P9	9432610244	TOYOTA 13 B 4/C. SENC. -DAIHATSU
tmDLLA150P59	0433171059	Toyota 14B



DMB**BUJÍAS DMB****ISUZU****ISUZU****1**

REPUESTOS

Pick Up 2.0 D	C190	01/83	12/93	bm818B7
Rodeo	C190 , C221, C223			bm718L6
Trooper 2.3		08/87	09/88	bm417M4
Trooper 2.8 TD	4JB1T			bm735M0
Trooper 2.8 Tdi	4JB1TC			bm735M0

DMB**BUJÍAS DMB****MITSUBISHI****MITSUBISHI****1**

REPUESTOS

Canter-35 2.5 D	4D56	01/86	03/93	bm021M7
Canter-35 2.5 D	4D56	04/93	>>	bm325M6
Galant 2.0 TD	4D68	10/96	02/00	bm325M6
L 200 2.5 D 2WD	4D56	06/95	06/01	bm550M5
L 200 2.5 D Turbo GLS	4D56 VGT	01/04	>>	bm325M6
L 200 2.5 TD	4D56	10/84	10/93	bm021M7
L 200 2.5 TD	4D56	11/93	>>	bm325M6
L 200 2.5 TD	4D56	11/93	06/01	bm550M5
L 200 2.5 TD Intercooler 2WD	4D56	01/96	>>	bm325M6
L 300 2.5 D Van 2WD	4D56	11/86	05/93	bm021M7
L 300 2.5 D Van 2WD	4D56	06/93	12/00	bm325M6
Lancer 2.0 D	4D68	05/92	12/96	bm325M6
Space Wagon 2.0 TD	4D68	06/92	11/00	bm325M6

DMB**BUJÍAS DMB****TOYOTA****TOYOTA****1**

REPUESTOS

Corolla 2.0 D	2C			bm225M5
Corolla 2.0 Sedan TD	1CDFTV	10/01	05/04	bm555M0
4-Runner 2.4 TD	2LT	01/90	11/95	bm522M0
Dyna 100 2.5 D	2L	09/88	05/95	bm522M0
Dyna 150 2.8 D	3L	09/88	05/95	bm522M0
Dyna 3.0 D				bm717L7
Hi Ace 2.4 Van D	2L	08/89	08/04	bm522M0
Hi Ace 4WD 2.5 D		08/93	>>	bm522M0
Hilux 2.4 D	2L	08/84	07/98	bm322F9
Hilux 2.5 TD	2KDFTV	07/05	>>	bm555M0
Hilux 2.5 16v TD	2KDFTV	>>	12/11	bm555M0
Hilux 2.8 D	3L	08/95	07/98	bm522M0
Hilux 3.0 D	5LE	01/02	02/05	bm225M5
Hilux 3.0 Tdi	1KDFTV	05/05	>>	bm555M0

**CAD**
2025

Land Cruiser 2.4 TD	2LT			bm748C9
Land Cruiser 3.4 D	3B			bm821Q4
Land Cruiser 4.2 TD	1HDT	01/90	01/95	bm225M5
Liteace 1.8 D	1C	10/82	08/85	bm022F6
Pick Up Hi Lux 4WD 2.4 D	2L	09/88	08/97	bm522M0
RAV4 2.0 TD	1CDFTV	05/01	11/05	bm555M0

ssG1338.A7

 2P 19MM
M12X1.5

Peugeot/Citroen	Toyota
1338.A7	89422020
1338.88	SU001-01117
96368024	Vauxhall
96367771	3639492
96284546	Fiat/Alfa Romeo/Lancia
96368023	9628454680
9670340380	
9636777180	

Sensor de temperatura DMB

 TOYOTA COROLLA 1.9 - AYO 1.0/1.2
VAUXHALL CROSSLAND 1.2/GRANDLAND 1.6
CORSA MK5 1.2

ssG1338.C1

Volvo	2P
30757235	L-53MM
30711088	Peugeot
8653683	1338.C1
Land Rover	1338.G8
LR 001207	1338.G5
LR 006857	Ford
Mitsubishi	1427774
Mn982202	1342631
Toyota	6G9Q12A648AA
SU001-00639	1204700
	1231943



Sensor de temperatura DMB

 SUZUKI GRAND VITARA 2.0/LIANA BERLINA 1.4
SX4 I HATCHBACK 1.6 - TOYOTA AYO 1.4
PROACE FURGON 1.6/2.0

ssR5001866447

Sensor de presión

MITSUBISHI GRANDIS
Renault
5001866447
0501214244

cm1102-014

Juego de juntas para bomba CP1H3 - Con filtro

NISSAN FRONTIER 2.8 - 4,07TCE
cm1102-015

Teflón 11mm



Juego de juntas para bomba

NISSAN
cm1103-010

Válvula dosificadora de caudal bomba CR

NISSAN 110/115/120/150 DCI
Bosch
1465Z50010
0928400672

cm1103-018

Válvula dosificadora de caudal bomba CR

ISUZU MOTOR 4JB1
Isuzu
0445010182
0445010198
0445010219
0445020046
0445020123
044511029
0445110291

Bosch
1465Z50018
0928400726
0928400728
0928400802

cm1103-029

Válvula dosificadora de caudal bomba CR

NISSAN FRONTIER 2.8 MWM
Bosch
1465Z50029
0928400848
MWM
7006536R1

REPUESTOS

cm1103-064



Bosch
1465Z50064
0928400674
Renault
8201011874

Válvula dosificadora de caudal bomba CR

TOYOTA YARIS 1.4 D-4D

cm1103-069



Bosch
1465Z50069
0928400607
0928400633
0928400682

Válvula dosificadora de caudal bomba CR

HYUNDAI H1 2.5 CRDI - KIA SORENTO 2.5 CRDI

cm1103-082



Bosch
1465Z50082
0928400608
0928400713

Válvula dosificadora de caudal bomba CR

HYUNDAI H1 2.5 CRDI - KIA SORENTO 2.5 CRDI

cm1103-083



Bosch
1465Z50083
0928400675
0928400714
Renault
7701068143
Suzuki
15610-67JG1-000

Válvula dosificadora de caudal bomba CR

SUZUKI GRAND VITARA 1.9 DCI

cm1103-606



Bosch
0928400606

Válvula reguladora de presión/unidad de medición

TOYOTA YARIS/ETIOS 1ND-TV (1.4 D-4D)

cm1103-633



Bosch
0928400633
0928400682

Válvula reguladora de presión/unidad de medición

HYUNDAI H1 - KIA SORENTO 2.5 CRDI

cm1103-653



Bosch
0928400653
0928400574
Silverado
8973698501

Válvula reguladora de presión/unidad de medición

CHEVROLET SILVERADO NISSAN FRONTIER

cm1103-983



Bosch
1462C00983
0928400752
0928400800

Válvula dosificadora de caudal de bomba CR

HYUNDAI SANTA FE 2.0/2.2 CRDI KIA CARNIVAL/SORENTO/SPORTAGE 2.0/2.2 CRD

REPUESTOS

cm1122-431



Inyectores
0445110062 0986435077
04451102276
04451102404

Bosch
0433175431

Tobera Common Rail - D5LA142P1474

SUZUKI GRAND VITARA

cm1122-449



Inyectores
0445120059
0445120231

Bosch
0433175449

Tobera Common rail - D5LA128P1510

KOMATSU PC200-8/SAA6D107E-1 QSB6,7 TIER 3/TIER 4/STAGE 4,5 6,7LTS - HYUNDAI HL770-7A QSL8,9

cm1122-510



Inyectores
0445120231
0986435597

Bosch
0433175510
Lucas/Delphi
LDFN 0459

Tobera Common rail - D5LA128P5510

CUMMINS SAA6D107 E-1 - KOMATSU PC 200-8 QSB6,7

cm1122-693



Inyectores
0445110081

Bosch
0433171693

Tobera Common Rail DLLA148P1067

NISSAN FRONTIER/XTERRA 2.8E 4.07TCE

cm1122-755



Inyector
0445110290
0445110126
0445110729

Bosch
0433171755

Tobera Common rail - DLLA150P1197

HYUNDAI TUCSON STA.FE 2.0 - KIA STORTAGE 2.0

cm1122-848



Inyector
0445110186
0445110279
0445110730

Lucas/Delphi Bosch
LDFN0345 0433171848
Zexel F01G00100F
105017-7420

Tobera Common rail - DLLA156P1368

HYUNDAI STARDEX H-1 2.5 CRDI

cm1122-889



Inyector
044510183
0445110316
0445110331

Bosch
0433171889 **Ford** 951 93183910
Fiat 9593 BA 93190435
55197875 1538758 **Suzuki**
55197124 15710 86J20 000
71794966

Tobera Common Rail - DLLA150P1437

SUZUKI SPLASH SWIFT 1.3 DDIS

cm1122-914



Inyector
0445110239
0445110311

Bosch
0433171914

Tobera Common Rail DLLA149P1471

SUZUKI SX4

cm1122-932



Inyector
0445110725
0445110246
0445110257
0445110258

Bosch
0433171932
Hyundai
3380027400

Tobera Common Rail - DLLA150P1511

KIA MAGENTIS - HYUNDAI SONATA/TUCSON 2.0 CRDI

REPUESTOS

cm1125-509



Inyector
0445110485
0445110652

Bosch
F00VC01509

Válvula de tercera etapa

NISSAN KUBISTAR 1.5 DCI

REPUESTOS

cm1141-010



Bosch
0281002718

Válvula reguladora de presión
HYUNDAI XTREE - KIA TRAJET
2.0 CRDI

cm1141-011



Bosch
0281002445

Válvula reguladora de presión
HYUNDAI SANTA FE/TUCSON/XTREK/TRAJET XG VGT 2.0
KIA CARENS II 2.0

cm1141-012



Bosch
0281002698
Mercedes Benz
6110780549

Válvula reguladora de presión
HYUNDAI H1 2.5 CRDI/130 1.6 CRDI - 2.0 CRDI/SANTA FE
2.2 CRDI

cm1141-017



Bosch
0281002829

Válvula reguladora de presión de rampa CR 0445214119 0445214265
HYUNDAI IX55 3.0 V6 CRDI
KIA MOHAVE 3.0 V6 CRDI

cm1141-019



Bosch
0281002943
0281002718
0281002732
Hyundai
3140227010

Válvula reguladora de presión de rampa CR 0445213007
HYUNDAI ACCENT 1.5/SANTA FE 2.0
KIA CARENS/SPORTAGE/CERATO 2.0

cm1141-023



Bosch
0281006037
Hyundai
314022F000

Válvula reguladora de presión de rampa CR 0445214211 0445216040
HYUNDAI SANTA FE 2.0/2.2 CRDI

REPUESTOS

cm1142-035



Bosch
0281006035
Hyundai
314012F000

Sensor de presión de rampa CR 0445214211 0445216041
HYUNDAI SANTA FE 2.0/2.2 CRDI/TUCSON 2.0
KIA CARNIVAL 2.2 CRDI/SORENTO 2.0/2.2 CRDI
SPORTAGE 2.0 CRDI

cm1142-053



Bosch
0281006053
0281002706
0281002707
0281006158
0281006244
0281006364
0281006425

Ford
04216218
Hino
5227621090
Volvo
21407309
7421-40-7309
7421-45-5919

Sensor de presión de rampa CR 0445214070
NISSAN URVAN 3.0 ZD30

cm1142-863



Bosch
0281002863
0281006808

Sensor de presión de rampa CR 0445213017 0445214180
HYUNDAI - KIA 1.7/2.0/2.5 CRDI

cm1142-907



Bosch
0281002907
0281002720
0281002920

Sensor de presión de rampa CR 0445214082 0445224026
CHEVROLET S10 - NISSAN FRONTIER 2.8 MWM

cm1142-908



Bosch
0281002908
0281002568
0281002734
0281002865
KIA
314004A010

Sensor de presión de rampa CR 0445214066 0445214061
KIA SORENTO 2.5 CRDI

cm1142-909



Bosch
02810002909
0281002522
0281002788
0281002866
0281002867
Fiat
504229208
Hyundai
31401-27000
31401-27001

Iveco
42567918
42569152
504229208
Renault
7701068387
7701069617
7701474554
7701478058
8200600206
8200600208

Sensor de presión de rampa CR 0445214035 0445214036
HYUNDAI ELANTRA/SANTA FE
TRAJET/TUCSON 2.0 CRDI



VÁLVULAS REGULADORA DE PRESIÓN COMMON RAIL



ISUZU

1203

1

REPUESTOS

cm1203-903A



Lucas/Delphi
9109-903A

Valvula reguladora de presion Delphi

KIA CARNIVAL I 2.2 L

cm1203-530A



Para bomba Delphi
A6510740084/28269520

Lucas/Delphi Hyundai
9307-530A 33115-4A400
9109-930A 33115-4A000
7135-818
9109-946
28233374

Valvula reguladora de caudal DMB

KIA K2500 K2900 - HYUNDAI H1 H100



KITS DE REPARACIÓN DE BOMBAS DE ALTA PRESIÓN COMMON RAIL



ISUZU

1402

1

REPUESTOS

cm1402-001



Denso
294009-0030
294009-0031
294009-0032

Juego de juntas

TOYOTA - NISSAN



VÁLVULAS REGULADORAS DE PRESIÓN COMMON RAIL



ISUZU

1403

1

REPUESTOS

cm1403-001



Denso
04226-0L010
294200-0040

Válvula reguladora de presión de combustible

TOYOTA REFORMA - DENSO

cm1403-001A



Denso
04226-0L010
294200-0040

Válvula reguladora de presión de combustible

TOYOTA REFORMA - DENSO

cm1403-002



Mitsubishi
294200-0360
294009-0250
294009-0251
294200-0300

Válvula reguladora de presión - Denso

**TOYOTA - MITSUBISHI L200
NISSAN NP300 - MAZDA**

cm1403-002A



Mitsubishi
294200-0360
294009-0250
294009-0251
294200-0300

Válvula reguladora de presión - DMB

**TOYOTA - MITSUBISHI L200
NISSAN NP300 - MAZDA**

cm1403-005



Válvula reguladora de presión

TOYOTA 3.0/2.5

cm1403-005A



Válvula reguladora de presión

TOYOTA 3.0/2.5 ALTERNATIVA

cm1403-007A



Denso
294200-0300
294200-0160
294200-0370

Válvula regula de presión de combustible corta

TOYOTA 2.5/3.0

cm1403-008



Denso
294200-0270
294009-1221
Hyundai
04226-E0061
Isuzu
33130-45700

Válvula reguladora de presión de combustible

HYUNDAI - HINO - ISUZU

cm1403-010



Denso
294200-2750
294200-4750

Válvula reguladora para bomba alta presión

8-98145484-1
**ISUZU 6HK1/4HK1/4JK1 4JJ1
MITSUBISHI L200/TRITON 2.5 DT**



REPUESTOS

cm1403-011



Denso
294200-0042
04226-0L020
294200-0040
294200-0093

Válvula dosificadora de caudal de bomba CR
TOYOTA HILUX 2.5/3.0 VIGO/FORTUNER PRADO 1KD/INNOVA COMMUTER 2KD FTV T25 2.0

cm1403-012



Denso	Isuzu	Opel/GM
294200-3660	8-98043686-0	8191B5
294200-0660	8-98043686-1	
8171613043011	8-98043686-2	
DCRS300120	8-98043686-3	
John Deere	8-98043686-4	
DZ111135	8-98043686-5	
RES30337	8-98043686-6	
Re531804	8-98043686-7	
Mazda	8-98043686-8	
RFYZ 13 Sm0	8-98043686-9	
Mitsubishi	Nissan	
1460A049	A6860-AW420	
	A6860-AW42B	

Válvula dosificadora de caudal de bomba CR
ISUZU ELF 400/450/500/600

cm1403-013



Denso
294200-2760
1460A056
2940200-2760
294200-4760
DCR5301700
SM294009-12904M
Isuzu
8-98145502-1

Válvula dosificadora de caudal de bomba CR
ISUZU D-MAX 2.0 - MITSUBISHI L200 2.5 DI-D NISSAN FRONTIER/NP300 YD25DDTI

cm1403-014



Toyota
294200-0300
294200-03002F
294200-0301
Denso
97204-0300

Válvula dosificadora de caudal de bomba CR
TOYOTA HILUX 2.5/3.0

REPUESTOS

cm1420-A041



Mitsubishi
1465A041
Denso
095000-5600
DCR1105600
095000-5601
095000-5602
095000-5603

Inyector Common Rail con código QR
MITSUBISHI L200 TRITON/MONTERO/CHALLENGER 4D56 EURO 4 2.5

cm1420-A054



Denso
095000-5760
095000-5761
Mitsubishi
1465A054

Inyector Common Rail con código QR
MITSUBISHI L200 / TRITON / MONTERO 3.2

cm1420-A307



Denso
095000-8110
Mitsubishi
1465A307

Inyector Common Rail con código QR
MITSUBISHI L200 / TRITON / MONTERO 3.2 4M40 / 4M41T

cm1420-A439



Denso
295050-1760
295050-1761
Mitsubishi
1465A439
1465A429

Inyector Common Rail con código QR
MITSUBISHI L200 / TRITON - FIAT FULLBACK 2,4 D

cm1420-0E010



Denso
295700-0550
296700-0160
296700-0150
296700-0520
Toyota
23670-0E010
23670-09420
23670-19015
23670-11010

Inyector Common Rail con código QR
TOYOTA FORTUNER/HILUX/LAND CRUISER 1GD 2,8

cm1420-0E020



Toyota
23670-0E020
23670-09430
23670-11020
23670-19025
Denso
295700-0560
295700-0090
295700-0120
295700-0530
295700-0560

Inyector Common Rail con código QR
TOYOTA HILUX / FORTUNER 2.4

cm1420-0E060



Denso
295700-1130
23670-08020
295700-11305G
295700-11306E
Toyota
23670-0E060
23670-09470

Inyector Common Rail con código QR - 6 Pines
TOYOTA HILUX 1GD 2.8

cm1420-0E070



Denso
23670-09460
295700-1140
Toyota
23670-0E070

Inyector Common Rail con código QR - 6 Pines
TOYOTA HILUX 2GD 2.4

cm1420-E0020



Denso
23670-E0020
23670-E0021
095000-6614
095000-6610
095000-6611
095000-6612
095000-6613
095000-0581
095000-0582

Inyector Common Rail
HINO 500 MOTOR J08E/J05E

REPUESTOS

cm1420-EB70A



Denso
095000-6250
095000-6251
095000-6252
095000-6253
Nissan
16600-EB70A
16600-EB70B
16600-EB70C

Inyector Common Rail con código QR

NISSAN FRONTIER/NAVARRA/PATHFINDER 2.5 YD25

cm1420-5X30A



Denso
295050-1050
295050-1051
295050-1052
295050-1053
295050-1054
295050-1055
295050-1056
295050-1057
295050-1058
295050-1059

Inyector Common Rail con código QR

NISSAN NAVARA/PATHFINDER/NP300 2.5

cm1420-010



Toyota
23670-0L010
23670-0P360
23670-0L070
23670-30300
23670-39255
23670-39275
Denso
095000-7761
095000-5520
095000-5930

Inyector Common Rail con código QR

TOYOTA HILUX/HIACE/VIGO 2.5

cm1420-050



Toyota
23670-0L050
23670-39216
23670-39186
23670-09330
Denso
095000-8290

Inyector Common Rail con código QR

TOYOTA HILUX 3.0

cm1420-090



Toyota
23670-0L090
23670-09350
Denso
295050-0520
295050-0180

Inyector Common Rail con código QR

TOYOTA HILUX 3.0 EURO 4

cm1420-110



Toyota
23670-0L110
23670-09380
23670-30420
Denso
295050-0810
295050-0800
295050-0620
095050-0540

Inyector Common Rail con código QR

TOYOTA HILUX/HIACE/DYNA 2.5

cm1420-00613



Isuzu
8981600613
Denso
095000-8930
095000-8933
095000-6366
095000-6363
8976097880
8981600610

Inyector Common Rail

ISUZU NKR/NPR/NQR 4HK1 5.2

cm1420-82473



Denso
295050-0930
295050-0933
Isuzu
8981782472
8981782473

Inyector Common Rail

ISUZU NHR REWARD 4JH1 3.0

dn23670-0L050



Denso
236700L050

Inyector completo

TOYOTA HILUX 3.0

cm1420-00613



Isuzu
8981600613
Denso
095000-8930
095000-8933
095000-6366
095000-6363
8976097880
8981600610

Inyector Common Rail

ISUZU NKR/NPR/NQR 4HK1 5.2

cm1420-16041



Denso
095000-6980
095000-6981
095000-6982
095000-6983
095000-6984
095000-6985
095000-6986
095000-6100
Chevrolet
8980116041

Inyector Common Rail con código QR

CHEVROLET ISUZU/D-MAX
ISUZU ELF 300 3.0 4JJ1

cm1420-50300



Chevrolet
8974350300
8981006932
8981066931
8981066930
Denso
095000-8341

Inyector Common Rail con código QR

CHEVROLET ISUZU/D-MAX 3.0 4JJ1

cm1420-82473



Denso
295050-0930
295050-0933
Isuzu
8981782472
8981782473

Inyector Common Rail

ISUZU NHR REWARD 4JH1 3.0

cm1420-97032



Chevrolet
8973297032
8973297031
8973297033
8973297034
89773297036
Denso
095000-5473
095000-2472
095000-5474

Inyector Common Rail con código QR

CHEVROLET ISUZU ELF 400 /ELF 450 5.2 - 4HK1/6HK1

cm1420-82473



Denso
295050-0930
295050-0933
Isuzu
8981782472
8981782473

Inyector Common Rail

ISUZU NHR REWARD 4JH1 3.0

cm1420-97032



Chevrolet
8973297032
8973297031
8973297033
8973297034
89773297036
Denso
095000-5473
095000-2472
095000-5474

Inyector Common Rail con código QR

CHEVROLET ISUZU ELF 400 /ELF 450 5.2 - 4HK1/6HK1

dn23670-0E010



Denso
295700-0550
295700-0160
295700-0150
295700-0520
Toyota
23670-0E010
23670-09420
23670-19015
23670-11010

Inyector Common Rail con código QR

TOYOTA FORTUNER/HILUX/LAND CRUISER 1GD 2.8

dn23670-0E020



Toyota
23670-0E020
23670-09430
23670-11020
23670-19025
Denso
295700-0560
295700-0090
295700-0120
295700-0530
295700-0560

Inyector Common Rail con código QR

TOYOTA HILUX / FORTUNER 2.4

REPUESTOS

cm1422-077



Inyectores
295050-1760
1465A439
Denso
G3S77
293400-0770
DLA148G3S77

Tobera common rail
MITSUBISHI L200/TRITON
FIAT FULLBACK 2,4 D

cm1422-096



Inyectores
095000-5471
095000-5361
095000-8901

Denso
093400-1096

Tobera Common Rail - DLA158P1096
MITSUBISHI L200/TRITON
FIAT FULLBACK 2,4 D

cm1422-320



Denso
093400-9320

Tobera common rail - DLA148P932
NISSAN NP300

cm1422-470



Inyector
095000-6250

Denso
093400-9470

Tobera Common Rail DLA152P947
CHEVROLET S10 - NISSAN

cm1422-480



Inyector
095000-6353

Denso
093400-8480

Tobera Common Rail DLA155P848
NISSAN

cm1422-630



Inyectores
095000-5921
23670-0L020

Denso
093400-8630

Tobera Common Rail DLA155P836
TOYOTA HILUX 3.0

cm1422-640



Inyectores
095000-5931
23670-0L010

Denso
G3S33

Tobera Common Rail
TOYOTA HILUX 2.5 3ERA GENERACIÓN

cm1422-700



Inyector
095000-5600

Denso
093400-8700

Tobera Common Rail DLA145P870
MITSUBISHI L200 4D56

cm1422-720



Inyector
095000-5650

Denso
093400-8720

Tobera Common Rail DLA148P872
NISSAN FRONTIER

cm1422-750



Denso
093400-8750

Tobera common rail DLA148P875
MITSUBISHI L200 / PAJERO - 3,2 - 4M41

cm1422-800



Denso
093400-9800

Tobera common rail DLA152P980
ISUZU RODEO / D-MAX - 4JJ1 3.0L

REPUESTOS

cm1425-001



Válvula plaqueta para inyector
TOYOTA - DENSO

cm1425-004



Válvula plaqueta de inyector
TOYOTA HILUX/FORTUNER 2.4
HILUX 2.8

Inyectores
23670-0E020
23670-0E010

Denso
G4
295040-9440

cm1425-005



Válvula plaqueta de inyector Common Rail
TOYOTA HILUX 3.0 - DESPIECE

Inyectores
095000-8290 095000-5160
095000-5050 095000-5190
095000-5150 095000-5230

Denso
ND5051-5

REPUESTOS

cm1425-005A

Válvula plaqueta para inyector

TOYOTA HILUX 2.5 - DENSO
cm1425-006

Válvula plaqueta de inyector

TOYOTA HILUX 3.0

 Inyectores
 23670-0L090/23670-30400
 095000-1440/295050-0520
 295040-6280

Denso
#507
KS11
cm1425-009

Válvula plaqueta de inyector Common Rail

TOYOTA HILUX 2.5 - DESPIECE

 Inyectores
 095000-5086 095000-5810
 095000-5550 095000-7731
 095000-5801 095000-7761

Denso
ND5051-9
cm1425-009A

Válvula plaqueta para inyector

TOYOTA HILUX 3.0 - DENSO
cm1425-012

Válvula plaqueta para inyector

NIPON DENSO
cm1425-019

 Válvula plaqueta de inyector
CHEVROLET ISUZU ELF 400/ELF 450
5.2 - 4HK1/6HK1

 Inyectores
 095000-8900
 095000-8901

Denso
#19
cm1425-033

Válvula plaqueta de inyector

TOYOTA HILUX 2.5

 Inyectores
 23670-0L110
 23670-30420

Denso
#SF03
cm1425-077

 Válvula plaqueta de inyector
MITSUBISHI L200/TRITON
FIAT FULLBACK 2,4 D

 Inyectores
 295050-1760
 1465A439
Denso
#10
 295040-6280
 295040-6290

cm1425-088

Plaqueta inyector

TOYOTA COROLLA
cm1425-509

Válvula plaqueta de inyector

ISUZU NHR REWARD 4JH1 3.0

 Inyectores
 295050-0930/8981782473
 295050-0931/8981782472

Denso
#509

REPUESTOS

cm1444-0281

 Válvula limitadora de presión de combustible para riel
NISSAN NP300 - MITSUBISHI L200 - HYUNDAI HD78
ISUZU D-MAX - JOHN DEERE
Denso
 095420-0281
 095420-0260

cm1444-0670

 Válvula limitadora de combustible para riel
TOYOTA PRADO/HIACE/HILUX
Bosch Denso
 095420-0670
 095420-0280

REPUESTOS

tg6C60-01

Valeo
2220306
2548207
INA Volkswagen
F-233593.1 03D903119A
Opel Zen
93297735 5374
SKF
VKM03111

Tensor fijo

NISSAN FRONTIER 2.8 MOTOR MWM
tg6C70-06

Cód. Originales
166200L02027415-30020
27415-0L030
27060-30020
INA
F-567525

Tensor

**TOYOTA HILUX 2.5 TD 2KDFTV/KDN/LN1/RZN168
HILUX PICK-UP 2.5 D-4D (2KD-FTV) 3.0 D-4D**
tg6616-09

Cód. Originales
166200L020

Tensor

TOYOTA HILUX LAND CRUISER 3.0D
tg6616-10

Cód. Originales
166200L020

Tensor

TOYOTA HILUX EN V SR4/SR
tg6616-15

Cód. Originales
166200L020

Tensor

TOYOTA RAV III DESDE 2011
tg8440-20

Toyota
88440-0k020
88440-0k010
88440-0k380
88440-35130
88440-0k011
88440-35140
88440-0k030
88440-35090

Rueda tensora Poli V

**TOYOTA HILUX/PRADO J120/LAND CRUISER
FORTUNER II**
tg8440-60

Toyota
88440-0k160

Rueda tensora

TOYOTA HILUX 2.5 D

REPUESTOS

MTI 7100

Toyota
17341-30060-07

Manguito de silicona (4 capas) para turbo de 64x75
TOYOTA HILUX/LAND CRUISER/PRADO/HIACE/FORTUNER
MOTOR 2KDFTV 2.5/1KDFTV 3.0

MTI 7101

Toyota
17342-30010-07

Manguito de silicona (4 capas) para turbo de 50x78
TOYOTA HILUX/LAND CRUISER/PRADO/HIACE/FORTUNER
MOTOR 2KDFTV 2.5/1KDFTV 3.0

REPUESTOS

dmT-GT17-A**GT1749S**

Referencias
Garret
 715924-0004
Hyundai
 28200-42700
Kia
 28200-42610

**dmC-GT17-A****Garret**
433352-0031**HYUNDAI H100 - KIA FRONTIER/PREGIO
2.5 4D56TCi****dmT-GT17-B****GT1749**

Referencias
Garrett
 716938-0001
Hyundai
 28200-42560

**HYUNDAI H1 CRDI D4BH (4D56T) 2.5L****TF035****dmC-TF035-A****Mitsubishi**
49377-08510**HYUNDAI H1 4D56TD 2.5L****dmT-TF035-C TF035HL-10GK23-VG**

Referencias
Mitsubishi
 49135-07310
 49135-07311
 49135-07312
 49135-07300
Hyundai
 28231-27810

**dmC-TF035-C****Mitsubishi**
49135-09021
49135-09022**HYUNDAI SANTA FE - KIA
2.2 D4EB 16V****dmT-TF035-E****TF035**

Referencias
Mitsubishi
 4913504350
 4949766101
Hyundai
 2820042800

**HYUNDAI GRAND STAREX 1.5L 110HP**

REPUESTOS

dmT-GT25-B
GT2560LS
Referencias
Garret

700716-0018

700716-5018

Isuzu

8973105020

8973105021

8973105022

8973105023

8973170040

**ISUZU NPR/NQR/NRR TRUCK ELF400 BUS
4H 5,2L**
dmT-RHF4-A
RHF4
Referencias
Mitsubishi

8971397243

8971397243

8971397241

VG420014

VA420014

VB420014

dmC-RHF4-A
I-HI

VBX40011

VAX40011

TURBOALIMENTADOR ISUZU RHF4-VIBR 2.8
dmT-RHF4-B
RHF4
Referencias
I-HI

VC420037

VB420037

VA420037

Isuzu

8971856450

8972402101

**TURBOALIMENTADOR VIDA - CHEVROLET LUV
ISUZU D-MAX 2.5 4JA1L**
RHF5
Referencias
I-HI

VA430015

VB430015

VE430023

VA430023

dmC-RHF5-A
I-HI

VBX50016

**ISUZU TROOPER 3.0L - 4JX1TC
TROOPER ECOLÓGICO 3.1L - 4JG2TC**

REPUESTOS

dmT-K03-E

K03

Referencias
KKK
 53039700122
 53039880122
 53039700144
 53039880144
Hyundai
 28200-4A470



dmC-K03-E

Borgwarner
 1303043901
 200430001



KIA SORENTO CRDI 2.5 (D4CB) 170HP

dmT-GT1752S-A

GT1752S

Referencias
Garret
 733952-5004
 733952-0004
Hyundai
 28200-4A101



dmC-GT1752S-A

Garret
 433352-0032



KIA SORENTO CRDI 2.5 (D4CB)

dmT-TF035-C

TF035HL-10GK23

Referencias
Mitsubishi
 49135-07310
 49135-07311
 49135-07312
 49135-07300
Hyundai
 28231-27810



dmC-TF035-C

Mitsubishi
 49135-09021
 49135-09022



**KIA - HYUNDAI SANTA FE
 2.2 D4EB 16V**

REPUESTOS

dmT-RHF4-E

RHF4

Referencias
I-HI
 VF420088
 VB420088
 VC420088
Mitsubishi
 1515A029



TURBOALIMENTADOR - RHF4 VT10 - MITSUBISHI L200 2.5L

dmT-TD04-A

TD04

Referencias
Mitsubishi
 49377-03041
 49377-03043
 ME201636
 ME201258



TURBOALIMENTADOR - TD04 - MONTERO 2.8 INTERCOOLER

REPUESTOS

dmT-TF035-A TF035HM TD04 Referencias



Mitsubishi
MR212759
49177-07612
49177-02512
Hyundai
28200-42540

dmC-TF035-A Mitsubishi
49377-08510



TURBOALIMENTADOR - TF035HM / TD04 - L200

dmT-TF035-B TF035 Referencias



Mitsubishi
49135-03130
ME202578

dmC-TF035-B Mitsubishi
49135-08000



MITSUBISHI MONTERO 2.8 4M40

dmT-TF035-D TF035HL2 Referencias



Mitsubishi
49135-02652
MR968080
MR968081

dmC-TF035-D Mitsubishi
49135-08800



TURBOALIMENTADOR - TF035 - L200 2.5

REPUESTOS

dmT-BV40-A BV40 K03 Referencias



Borgwarner:
53039700268
53039700341
53039700373
53039880268
53039880341
53039880373
Nissan:
14411-1AT1A
14411-3XN1A
14411-3XN2A
14411-3XN3A

NISSAN URVAN E26
YD25 DDT 2.5L 140KW

dmT-GT20V-A GTA2056LV Referencias



Nissan
14411-EB70A
14411-EB70B
14411-EB70C
14411-EB70D
14411-EC00A
14411-EC00B
14411-EC00E

Garrett
767720-0001
764327-0001
769708-0001

dmC-GT20V-A Garret
767720-CCR



NISSAN NAVARA YD25DDTI 2.5L

REPUESTOS

dmT-HT12-A

HT12-19D
HT12-19B

Referencias
Hitachi
047229 047-229
047282 047-282
047663 047-663
2508279 250-8279
Nissan
14411-9S000
14411-9S001
14411-9S002



NISSAN NAVARA D22
ZD30 EFI 3.0L

dmT-RHF4-D

RHF4H VN2

Referencias
I-HI
VA420051
VB420051
VC420051
Nissan
14411-8H800



NISSAN X-TRAIL DI YD1T 2.2L

GTA2056LV

Referencias
767720-0002



NISSAN NAVARA 2.5L - YD25DDTI EURO III

GT2052S

Referencias
715330-0001
905292010068
724249-0001
905292010074



dmC-GT2052S-C

Garret
451298-0020



NISSAN FRONTIER / X-TERRA / NAVARA
MWM 2.8 - 4,07TCA - 4 CILINDROS

REPUESTOS

dmT-CT-A

CT16

Referencias
17201-0L030



dmC-CT-A

Toyota
17202-0L030



HILUX 2.5 2KD ELECTRÓNICO SIN INTERCOOLER

dmT-CT-B

CT16V

Referencias
17201-0L040
17201-30100
17201-30101
17201-30160



dmC-CT-B

Toyota
17202-0L030



TOYOTA HILUX SRV/SR 3.0
LANDCRUISER D-4D - FTV KZN130

REPUESTOS

dmT-CT-C

CT16

Referencias
Toyota
17201-30030



dmC-CT-C

Toyota
17202-30030
17202-30070



**TOYOTA HILUX HI ACE 2.5 (2KD)
LANDCRUISER**

dmT-CT-D

CT16V

Referencias
Toyota
17201-11080



dmC-CT-D

Toyota
17201-11080CCR



**TOYOTA HILUX/PRADO/FORTUNER
1GD-FTV 2.8L**

dmT-CT-E

CT16V

Referencias
Toyota
17201-11070



dmC-CT-E

Toyota
17201-11070



**TOYOTA HILUX/PRADO/FORTUNER
2GD-FTV 2.4L**

dmT-CT12B-A

CT12B

Referencias
17201-67010



**TOYOTA HILUX 3.0
LANDCRUISER - TD4**

dmT-CT-G

CT16

Referencias
Toyota
17201-0L080
17201-30140
17201-30141



dmC-CT-G

Toyota
CCR.17201-0L080
CCR.17201-30140
CCR.17201-30141



TOYOTA HILUX 2KD 2.5L D4D

dmT-CT16-A

CT16V

Referencias
Toyota
17201-11110



dmC-CT16-A

Toyota
17201-11110



HILUX 2.4 VNT

dmT-CT16-B

CT16

Referencias
Toyota
17201-11120



dmC-CT16-B

Toyota
CCR.17201-11120



TOYOTA HILUX 1GD-FTV 2.8L VNT

JAPONESSES



TOYOTA



HINO



NISSAN

ISUZU

LÍNEA LIVIANA

Catálogo de tuberías



- Tuberías flexibles y rígidas.
- Lubricación de turbo y descarga.
- Lubricación de aceite.
- Tuberías de inyección convencional y Common Rail.
- Tuberías de inyección para bancos de prueba convencional y Common Rail.
- Tuberías flexibles y rígidas para compresor.
- Tuberías de freno y dirección hidráulica.
- Tuberías de agua.

ATENCIÓN

Sobre presentación de muestra fabricamos todo tipo de tuberías para el automotor.



NL DH 1



- Daihatsu**
1) 23701-56080
2) 23702-56080
3) 23703-56080
4) 23704-56080

Conjunto de 4 tuberías de inyección

DAIHATSU DELTA

NL IZ 1



- Cod. Originales**
1) 8-97223923-1
2) 8-97223924-1
3) 8-97223925-1
4) 8-97223926-1

Conjunto de 4 tuberías de inyección

ISUZU 2.7 4JB1 (NKR)

NL IZ 2



- Cod. Originales**
1) 8-97209493-1
2) 8-97209494-1
3) 8-97209495-1
4) 8-97209496-1

Conjunto de 4 tuberías de inyección

ISUZU 3.9 4BD1T (NPR)

NL T 1



Conjunto de 4 tuberías de inyección

TOYOTA MOTOR B1

NL T 2



Tubería de inyección de alta presión. De bomba a rampa

TOYOTA 3.0 COMMON RAIL

NL T 3



Juego de 4 tuberías de inyección

TOYOTA HILUX 2.5 Y 3.0 ELECTRÓNICO

MV 0720



Ford
BK3Q6K679CD

Tubo entrada de aceite al turbo - 798166 / 812971 / 853333 / 822182

MAZDA BT-50 3.2L

MV 4101



Tubo salida de aceite

MITSUBISHI 4 CIL.

REPUESTOS

EX 4



Exhibidor para 4 tuberías

VS

EX 5



Exhibidor para 5 tuberías

VS

EX 6



Exhibidor para 6 tuberías

VS