



# SCANIA

LÍNEA PESADA

## Catálogo de productos



- Repuestos de inyección diesel.
- Bombas de combustible.
- Filtros trampa de agua.
- Toberas elementos y válvulas.
- Inyectores.
- Sensores.
- Tensores.
- Mangueras de intercooler.
- Turbos Sobrealimentadores.
- Cajas y flexibles levanta cabina.
- Tuberías rígidas y flexibles.





# INDICE

INDICE  
CON LINEAS  
DE PRODUCTOS PARA  
CATÁLOGOS POR MARCAS DE  
VEHÍCULOS

## 1- Repuestos, Accesorios y Despiece para Inyección Diesel.

- Abrazaderas
- Anillos de Goma
- Arandelas
- Bombas Alimentadoras
- Bulones Perforados
- Mangueras Universales
- Cebadores
- Electroválvulas
- Filtros
- Juegos de Juntas
- Líquido aditivo Diesel Power
- Prefiltros
- Seguros para Caños de Inyección
- Uniones Orientables
- Válvulas
- Vasos

## 2- Toberas, elementos y válvulas "DMB" y toberas Common Rail e inyectores

## 3- Bujías Incandescentes "DMB".

## 4- Common Rail.

## 5- Tensores de correa.

## 6- Turbos "DMB"

## 7- Tuberías Flexibles y rígidas.

- Para Inyección
- Para Combustible
- Para Aceite
- Para Dirección Hidráulica
- Para Accionamiento de Embrague
- Para Freno Hidráulico
- Para Conducción de Agua y Aire
- Para Aire Comprimido



# Guia explicativa uso de catalogo productos CMD.

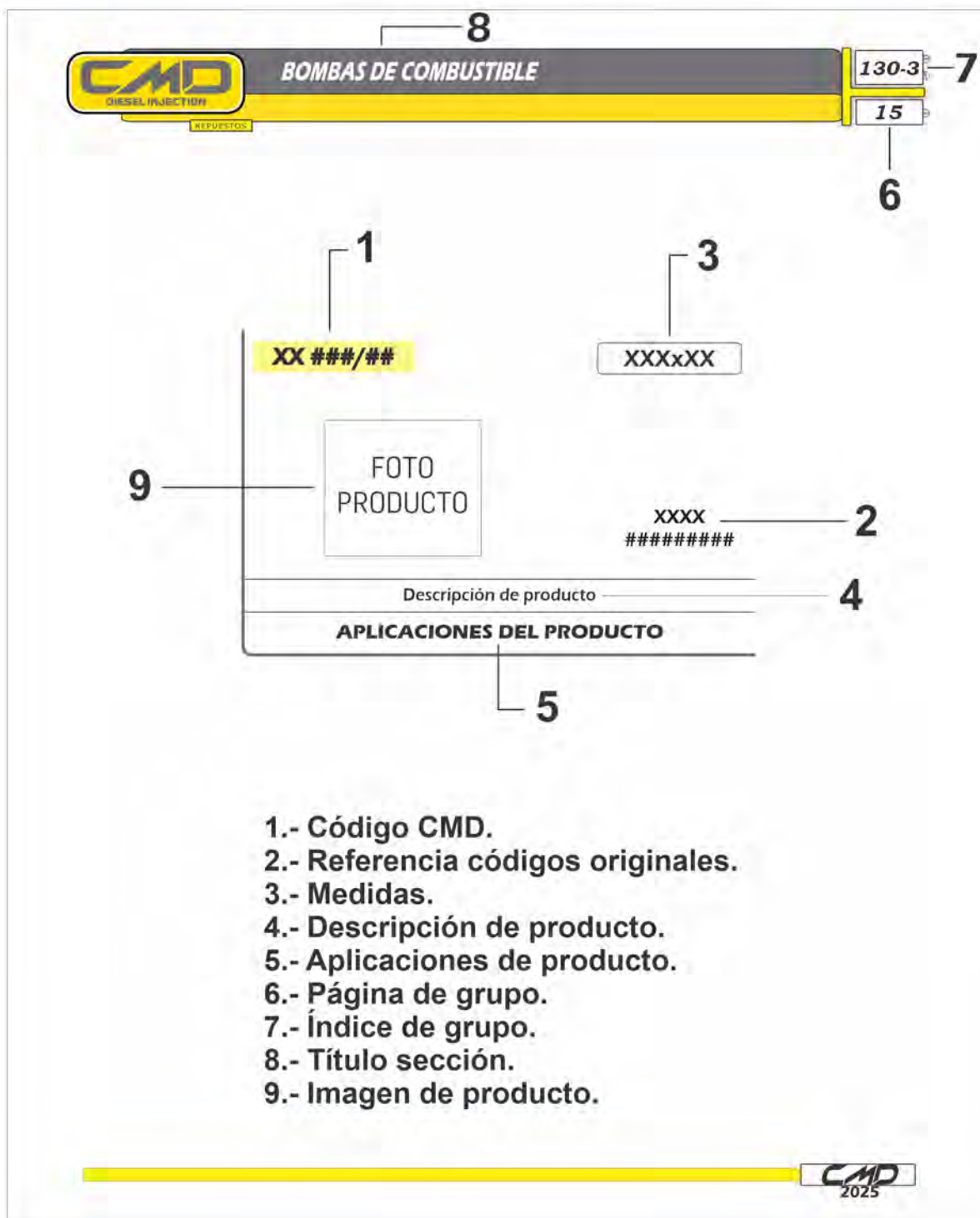

- 1.- Código CMD.
- 2.- Referencia códigos originales.
- 3.- Medidas.
- 4.- Descripción de producto.
- 5.- Aplicaciones de producto.
- 6.- Página de grupo.
- 7.- Índice de grupo.
- 8.- Título sección.
- 9.- Imagen de producto.

Las Marcas y Logos® que aparecen en los catalogos CMD pertenecen a sus respectivos dueños, y cuando son mencionadas estan a titulo informativo.

REPUESTOS

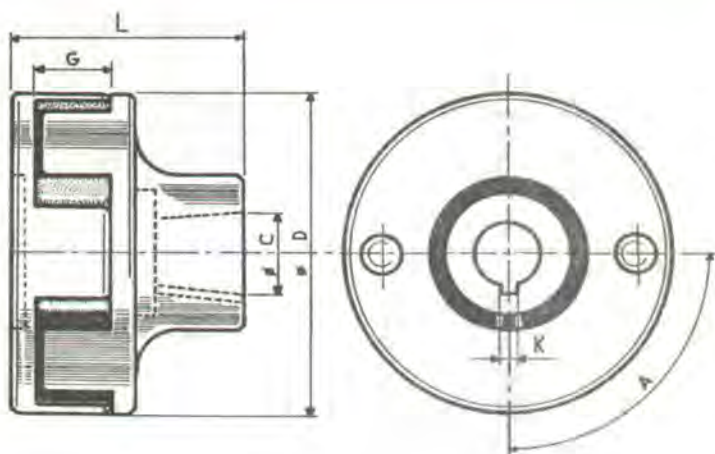

L	A	C	G	D	d	K	Cono	Cod. CMD
50	90°	16	16	74	37	3	A	AE 102/1
50	90°	19	16	74	37	4	B	AE 102/2
85	90°	16	16	74	37	3	A	AE 102/3
77		16	16	74	37	3	A	AE 102/4
51	90°	19	17	85	37	4	B	AE 102/6
52	90°	19	23	74	37	4	B	AE 102/9
43	*	20	16	105	*	4	CIL	AE 102/10
*	*	20	20	74	*	4,7	B	AE 102/12
68	90°	19	20	90	37	4	B	AE 102/13
*	*	20	31	99	*	4,7	CIL	AE 102/14
80	*	21	16	85	*	*	*	AE 102/15
70		16	23	74	37	3	A	AE 102/16
50	90°	19	20	90	37	4	B	AE 102/18
*	*	*	20	74	*	4,7	CIL	AE 102/19
50	90°	19	20	90	37	4	B	AE 102/20
*	*	20	*	105	*	4	*	AE 102/21
*	*	20	*	105	*	4	CIL	AE 102/22

AE 102/6



SCANIA VABIS

AE 102/7



SCANIA VABIS 150

AE 102/13



SCANIA VABIS

REPUESTOS

AG 103/2



Acople de Goma Sintetica

SCANIA

AG 103/7



Acople de Goma Sintetica

SCANIA VABIS

AG 103/12



Acople de Goma Sintetica

SCANIA 111 / 112

REPUESTOS

AH 104/1



Plana

SCANIA VABIS

AH 104/5



Arandela buje

SCANIA VABIS

AH 104/7



Scania  
192641

Para bomba "P" Arandela buje

SCANIA VABIS 111

REPUESTOS

**AH 104/8**



Plana

**SCANIA 111**

**AH 104/10**



280868

Arandela buje

**SCANIA 112**

**AH 104/11**



280869

Arandela plana

**SCANIA 112**

**AH 104/12**



306703

Arandela buje para lámina ondulada

**SCANIA 113**

**AH 104/13**



306704

Arandela plana para lámina ondulada

**SCANIA 113**

REPUESTOS

**AG 105/1**

6 mm



**Bosch**

2 916 699 083  
2 916 693 005  
2 916 690 005  
2 916 698 053  
2 916 699 132

Arandela grower

**VS**

**AG 105/2**

8 mm



Arandela grower

**VS**

**AG 105/3**

10 mm



Arandela grower

**VS**

**AG 105/4**

1/2 "



Arandela grower

**VS**

**AG 105/5**

9/16"



Arandela grower

**VS**

**AG 105/6**

16 mm



Arandela grower

**VS**

**AG 105/7**

6 mm



**Lucas**  
9007-200R

Arandela grower para bomba DPC

**VS**

**AG 105/8**

18 mm



**Bosch**  
2 916 693 012

Arandela grower para bomba P

**VS**

**AG 105/9**

20 mm



**Bosch**  
2 916 693 013

Arandela grower para bomba P

**VS**

REPUESTOS

**AG 105/10**

14 mm



Arandela grower

**VS**
**AG 105/11**

12 x 17 mm

**Bosch**  
1 420 151 001

Arandela grower de Regulador RSV

**VS**
**AG 105/12**

1"

**Bosch**  
2 916 699 093

Arandela grower para bomba tipo P

**VS**

REPUESTOS

CÓDIGO	MEDIDA (mm)		CÓDIGO	MEDIDA (mm)	
<b>AL 105/1</b>	4 x 9 x 1.25		<b>AL 105/15A</b>	19 x 23 x 1.25	
<b>AL 105/2</b>	5 x 9 x 1.25		<b>AL 105/15B</b>	18 x 25 x 1.25	
<b>AL 105/2A</b>	5 x 13 x 1.25		<b>AL 105/16</b>	20 x 26 x 1.25	
<b>AL 105/3</b>	6 x 10 x 1.25		<b>AL 105/17</b>	22 x 28 x 1.25	
<b>AL 105/3A</b>	7 x 10 x 1.25		<b>AL 105/18</b>	24 x 30 x 1.25	
<b>AL 105/3B</b>	7 x 14 x 1.25		<b>AL 105/19</b>	26 x 32 x 1.25	
<b>AL 105/3C</b>	7 x 14 x 2		<b>AL 105/20</b>	28 x 36 x 1.25	
<b>AL 105/4</b>	8 x 13 x 1.25		<b>AL 105/21</b>	30 x 36 x 1.25	
<b>AL 105/5</b>	8 x 12x 1 (doble)		<b>AL 105/22</b>	32 x 40 x 1.25	
<b>AL 105/6</b>	9 x 14.5 x 1.25		<b>AL 105/23</b>	34 x 42 x 1.25	
<b>AL 105/7</b>	10 x 14.5 x 1.25		<b>AL 105/23A</b>	35 x 41 x 1.25	
<b>AL 105/8</b>	11 x 17 x 1.25		<b>AL 105/24</b>	36 x 42 x 1.25	
<b>AL 105/9</b>	12 x 17 x 1.25		<b>AL 105/25</b>	38 x 46 x 1.25	
<b>AL 105/10</b>	13 x 20 x 1.25		<b>AL 105/25A</b>	39.5 x 53 x 0.5	
<b>AL 105/11</b>	14 x 20 x 1.25		<b>AL 105/26</b>	41 x 45 x 1.25	
<b>AL 105/11A</b>	14 x 23 x 1.25		<b>AL 105/26A</b>	41 x 55 x 1.25	
<b>AL 105/12</b>	15 x 21 x 1.25		<b>AL 105/26B</b>	41 x 55 x 0.5	
<b>AL 105/13</b>	16 x 21 x 1.25		<b>AL 105/27</b>	42 x 49 x 1.25	
<b>AL 105/13A</b>	16 x 24 x 1.25		<b>AL 105/28</b>	44 x 52 x 1.25	
<b>AL 105/14</b>	17 x 22 x 1.25		<b>AL 105/29</b>	46 x 54 x 1.25	
<b>AL 105/15</b>	18 x 23 x 1.25		<b>AL 105/30</b>	52 x 60 x 1.25	

REPUESTOS

CÓDIGO	MEDIDA (mm)
CO 105/1	4 x 9 x 1.25
CO 105/2	5 x 9 x 1.25
CO 105/3	6 x 10 x 1.25
CO 105/3A	6 x 10 x 1 (doble)
CO 105/3B	7 x 14 x 1.25
CO 105/4	8 x 12.5 x 1.25
CO 105/4A	8 x 11 x 1.25
CO 105/5	8 x 12 x 1 (doble)
CO 105/6	9 x 14.5 x 1.25
CO 105/7	10 x 14 x 1.25
CO 105/8	11 x 17 x 1.25
CO 105/9	12 x 17 x 1.25
CO 105/10	13 x 20 x 1.25
CO 105/11	14 x 20 x 1.25
CO 105/11A	14 x 23 x 1.25
CO 105/12	15 x 21 x 1.25
CO 105/13	16 x 21 x 1.25
CO 105/13A	16 x 24 x 1.25
CO 105/14	17 x 22 x 1.25
CO 105/15	18 x 23 x 1.25
CO 105/16	20 x 26 x 1.25
CO 105/17	22 x 26 x 1.25
CO 105/18	24 x 30 x 1.25
CO 105/19	26 x 32 x 1.25
CO 105/20	28 x 36 x 1.25
CO 105/21	30 x 36 x 1.25
CO 105/22	32 x 40 x 1.25
CO 105/23	34 x 42 x 1.25
CO 105/24	36 x 42 x 1.25

CÓDIGO	MEDIDA (mm)
CO 105/25	38 x 46 x 1.25
CO 105/26	41 x 45 x 1.25
CO 105/27	42 x 49 x 1.25
CO 105/28	44 x 52 x 1.25
CO 105/29	46 x 54 x 1.25
CO 105/30	52 x 60 x 1.25

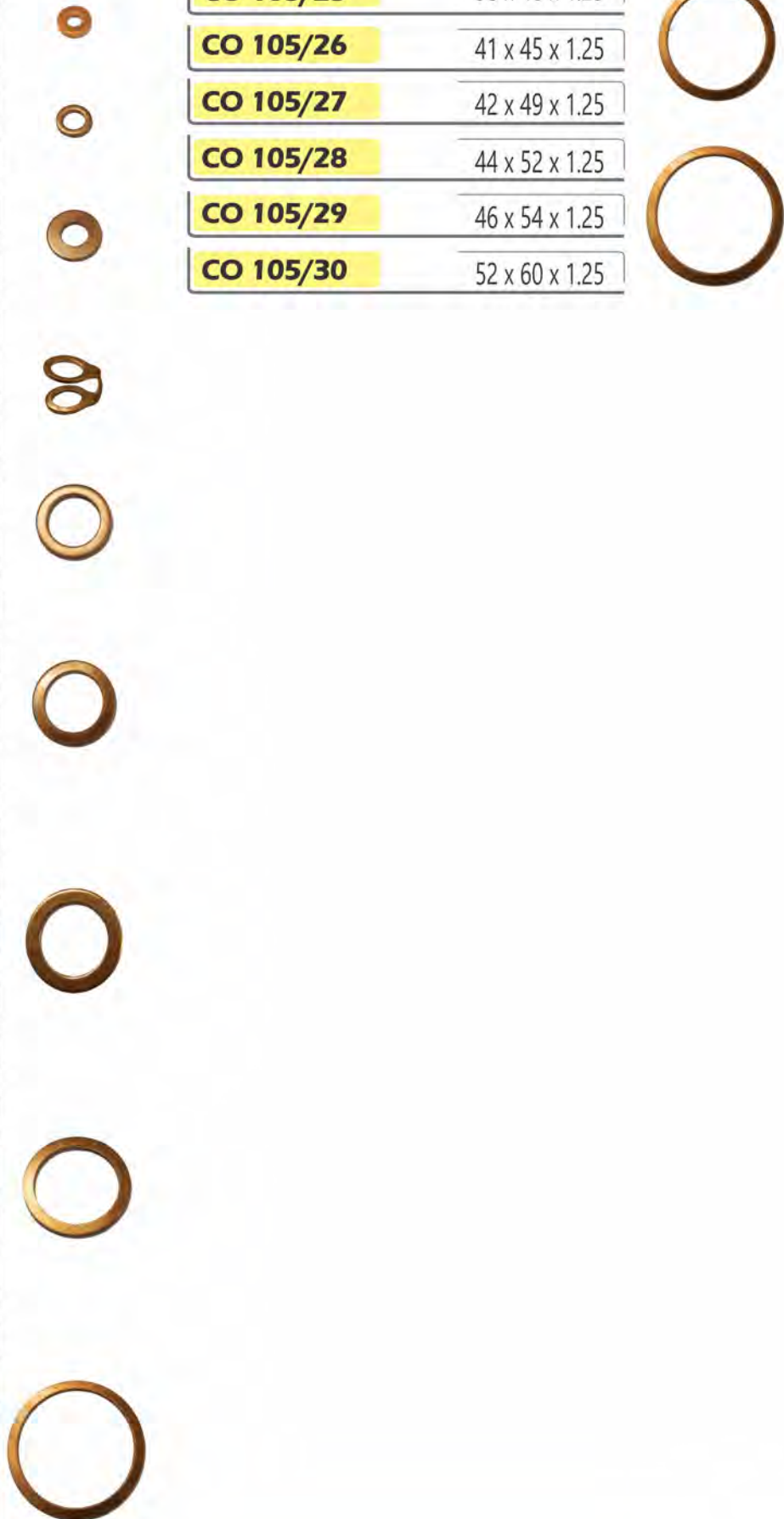

REPUESTOS

CÓDIGO	MEDIDA (mm)
FI 105/2	5 x 9 x 1.5
FI 105/2A	5 x 12 x 1.5
FI 105/3	6 x 10 x 1.5
FI 105/3A	6.5 x 12.5 x 1.5
FI 105/4	8 x 13 x 1.5
FI 105/6	9 x 14.5 x 1.5
FI 105/7	10 x 14 x 1.5
FI 105/8	11 x 17 x 1.5
FI 105/9	12 x 17 x 1.5
FI 105/10	13 x 20 x 1.5
FI 105/10A	13 x 24 x 1.5
FI 105/11	14 x 20 x 1.5
FI 105/12	15 x 21 x 1.5
FI 105/13	16 x 21 x 1.5
FI 105/13A	16 x 24 x 1.5
FI 105/14	17 x 22 x 1.5
FI 105/15	18 x 23 x 1.5
FI 105/16	20 x 26 x 1.5
FI 105/17	22 x 28 x 1.5
FI 105/18	24 x 30 x 1.5
FI 105/19	26 x 32 x 1.5
FI 105/20	28 x 36 x 1.5
FI 105/21	30 x 36 x 1.5
FI 105/22	32 x 40 x 1.5
FI 105/23	34 x 42 x 1.5
FI 105/24	36 x 42 x 1.5
FI 105/25	38 x 46 x 1.5
FI 105/26	41 x 45 x 1.5
FI 105/27	42 x 49 x 1.5

CÓDIGO	MEDIDA (mm)
FI 105/28	44 x 52 x 1.5
FI 105/29	46 x 54 x 1.5
FI 105/30	52 x 60 x 1.5



REPUESTOS

**AC 112/6**

9 x 15.5 x 2 mm



De cobre

**SCANIA 113**

**AC 112/17**

10 x 25 x 2 mm



De cobre

**SCANIA VABIS**

**AC 112/18**

10 x 19 x 2 mm



De cobre

Perkins  
920113

**SCANIA**

**AC 112/18A**

10 x 19 x 1.5 mm



De cobre

**SCANIA**

**AC 112/24**

9.1 x 19 x 2 mm



De cobre

**SCANIA K-112**

REPUESTOS

**AV 114/9**



De cobre para válvula de bomba inyectora

**SCANIA VABIS**

**AV 114/21**



De bronce

**SCANIA 112**

**Bosch**

2 410 105 005  
2 410 101 009

**AV 114/21A**



Entre válvula racord

**SCANIA**

**Bosch**

2 410 105 003

**AV 114/26**



**Bosch**  
2 410 029 001

De acero con pestaña para válvula de bomba P 700

**SCANIA 112**

**AV 114/27**



**Bosch**  
2 410 005 003

De acero plana para válvula de bomba P700

**SCANIA 112**

REPUESTOS

**AC 115/1**

25.5 x 29.5 x 1.2



**Bosch**  
2 440 105 000  
**Fiat**  
760 241

De cobre para tapón bomba alimentadora tipo Bosch

VS

**AC 115/2**

16 x 19



**Bosch**  
1 230 203 001

Para cebador y tapón chico bomba alim. tipo Bosch

VS

**AC 115/505**



**Cummins**  
4307148

Arandela para inyector HPI

SCANIA DC12/DT12 CUMMINS ISX/QSX

**AC 115/506**



Arandela de cobre externa de asiento de inyector

SCANIA DC12/DT12 CUMMINS ISX/QSX

REPUESTOS

**AC 116/7**

4 x 10 x 2.6



Arandela de cobre cónica para caño inyección espesor 0.50

VS

**AC 116/8**

4 x 10 x 2.6



Arandela de cobre cónica para caño inyección espesor 0.90

VS

REPUESTOS

	Pulgadas		Milímetros	
	Ø min	Ø max	Ø min	Ø max
<b>AB 117/1</b>	5/16	3/8	8	10
<b>AB 117/2</b>	3/8	1/2	10	12
<b>AB 117/2A</b>	7/16	17/32	11	11.5
<b>AB 117/3</b>	1/2	9/16	12	14
<b>AB 117/4</b>	9/16	5/8	14	16.5
<b>AB 117/5</b>	11/16	3/4	17	19.5



Fleje ancho 9 mm - Espesor 0.5 mm

**COMPACTA**

REPUESTOS

**SCANIA**

	Pulgadas		Milímetros	
	Ø min	Ø max	Ø min	Ø max
<b>AB 117/6</b>	5/16	5/8	8	16
<b>AB 117/7</b>	3/8	13/16	10	20
<b>AB 117/7A</b>	1/2	1	12	26
<b>AB 117/8</b>	3/4	1 1/4	20	32
<b>AB 117/9</b>	1 1/4	1 3/4	30	45
<b>AB 117/10</b>	1 9/16	2 1/8	40	55
<b>AB 117/11</b>	2	2 9/16	50	65
<b>AB 117/12</b>	2 3/8	3	60	75

	Pulgadas		Milímetros	
	Ø min	Ø max	Ø min	Ø max
<b>AB 117/13</b>	2 3/4	3 3/8	70	85
<b>AB 117/14</b>	3 1/8	3 3/4	80	95
<b>AB 117/15</b>	3 1/2	4 1/8	90	105
<b>AB 117/16</b>	3 5/16	4 1/2	100	115
<b>AB 117/17</b>	4 5/16	4 15/16	110	125
<b>AB 117/18</b>	5 1/8	5 11/16	130	145



Fleje ancho 8.5 mm - Espesor 0.8 mm

**MINI SUPER**

	Pulgadas		Milímetros	
	Ø min	Ø max	Ø min	Ø max
<b>AB 117/19</b>	1 3/8	1 3/4	35	45
<b>AB 117/20</b>	1 9/16	2 1/8	40	55
<b>AB 117/22</b>	2 3/8	3	60	75
<b>AB 117/23</b>	2 3/4	3 3/8	70	85
<b>AB 117/24</b>	3 1/8	3 3/4	80	95
<b>AB 117/25</b>	3 1/2	4 1/4	90	105
<b>AB 117/26</b>	3 3/8	4 1/2	100	115

	Pulgadas		Milímetros	
	Ø min	Ø max	Ø min	Ø max
<b>AB 117/27</b>	4 5/16	4 15/16	110	125
<b>AB 117/27A</b>	4 3/4	5 3/8	120	135



Fleje ancho 14.4 mm - Espesor 0.8 mm

**SUPER CIERRE RAPIDO**

	Pulgadas		Milímetros	
	Ø min	Ø max	Ø min	Ø max
<b>AB 117/29</b>	9/16	3/4	14	20
<b>AB 117/30</b>	5/8	7/8	16	22
<b>AB 117/31</b>	3/4	1 1/8	20	28
<b>AB 117/32</b>	1	1 3/8	25	35
<b>AB 117/33</b>	1 3/16	1 9/16	30	40
<b>AB 117/34</b>	1 3/8	1 3/4	35	45
<b>AB 117/34A</b>	1 1/2	2	38	50
<b>AB 117/35</b>	1 9/16	2 1/8	40	55
<b>AB 117/36</b>	1 3/4	2 3/8	45	60

	Pulgadas		Milímetros	
	Ø min	Ø max	Ø min	Ø max
<b>AB 117/37</b>	2	2 5/8	50	65
<b>AB 117/38</b>	2 3/8	3	60	75
<b>AB 117/39</b>	2 3/4	3 3/8	70	85
<b>AB 117/40</b>	3 1/8	3 3/4	80	95
<b>AB 117/41</b>	3 1/2	4 1/8	90	105
<b>AB 117/42</b>	3 5/16	4 1/5	100	115
<b>AB 117/43</b>	4 5/16	4 15/16	110	125
<b>AB 117/44</b>	5 1/8	5 11/16	130	145



Fleje ancho 14.4 mm - Espesor 0.8 mm

**TIPO AMERICANA**

	Pulgadas		Milímetros	
	Ø min	Ø max	Ø min	Ø max
<b>AB 117/90</b>	1/4	5/8	6	16
<b>AB 117/91</b>	7/16	13/16	11	20
<b>AB 117/92</b>	1/2	15/16	13	24



Fleje ancho 8 mm - Espesor 0.5 mm

REPUESTOS

	Pulgadas	
	Ø min	Ø max
AB 117/45	9	11
AB 117/46	11	13
AB 117/47	13	15
AB 117/48	15	17
AB 117/49	17	19
AB 117/50	19	21
AB 117/51	21	23
AB 117/52	23	25
AB 117/53	25	27
AB 117/54	27	29
AB 117/55	29	31
AB 117/56	31	33
AB 117/57	33	35
AB 117/58	35	37
AB 117/59	37	41
AB 117/60	41	44
AB 117/61	44	47
AB 117/62	47	50
AB 117/63	50	54
AB 117/64	54	58
AB 117/65	58	62
AB 117/66	62	66



**SOPORTAN ALTAS PRESIONES, REUTILIZABLES, CIERRE PERFECTO.  
SOPORTAN ALTAS TEMPERATURAS, ANTICORROSIVAS, ATÓXICAS.  
ECONOMÍA DE COSTO, FACILIDAD DE COLOCACIÓN.**

PI 161/101



Para abrazaderas plásticas

VS

REPUESTOS

AG 122/79



Bosch  
1 900 210 105

Para eje de pare de TPS

SCANIA

AG 122/85



Bosch  
2 440 210 019

Para racord reductor RAC 173/35 - tapón c/válvula

VS

AG 122/86



Bosch  
1 480 210 016

Para racord entrada de bbta. De llenado de circuito

VS

REPUESTOS

**AG 122/96**



**Bosch**  
2 440 210 010

Para racord tapón con válvula tipo M

**SCANIA**

**AG 122/97**



**Bosch**  
1 900 210 119  
2 440 210 013

Para racord tapón con válvula tipo M

**VS**

**AG 122/98**



**Bosch**  
2 440 210 012

Para racord tapón con válvula tipo M

**SCANIA**

**AG 122/99**



**Bosch**  
2 430 210 027

Para inyector

**SCANIA 113**

**AG 122/202**



**Bosch**  
1 410 210 014

Vitón inferior elemento bomba P

**SCANIA**

**AG 122/206**



**Bosch**  
2 410 210 049

Vitón elemento bomba P

**SCANIA 113**

**AG 122/207**



**Bosch**  
2 410 210 033

Vitón Racord porta válvula bomba P

**SCANIA 112 /113 DEUTZ**

**AG 122/208**



**Bosch**  
2 410 210 013

Nitrilo porta ruleman bomba P

**SCANIA**

**AG 122/209**



**Bosch**  
2 410 206 003

Para tapa inferior cuadrado 8 cilindros

**SCANIA**

**AG 122/210**

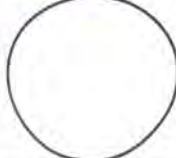

**Bosch**  
2 410 206 005

Para tapa inferior cuadrado 6 cilindros

**SCANIA**

**AG 122/211**



**Bosch**  
2 410 210 065

Nitrilo porta ruleman bomba P

**SCANIA 113**

**AG 122/212**



**Bosch**  
2 410 210 034

Vitón superior elemento bomba P

**SCANIA 112 STANDARD**

**AG 122/300**



**Bosch**  
2 430 206 004

Vitón para inyector

**SCANIA 112 STANDART**

**AG 122/301**



**Scania**  
249 928

Vitón para inyector - plano inyector roscado

**SCANIA 112 STANDART**

**AG 122/302**



**Scania**  
308 399

Viton para inyector (copita)

**SCANIA 112 STANDART**

**AG 122/310**



Para inyector

**SCANIA 124 SERIE 4 (MECÁNICO)**

**AG 122/600**



Para inyector de bomba sistema PDE - de vitón

**SCANIA SERIE 4**

**AG 122/601**



Para inyector de bomba sistema PDE - de vitón

**SCANIA SERIE 4**

REPUESTOS

AG 122/602



Para inyector de bomba sistema PDE - de vitón

**SCANIA SERIE 4**

REPUESTOS

BA 127/6



Cabeza frezada

**SCANIA VABIS**

BP 129/1

8 x 1 x 17 mm



Para descarga de inyector

**SCANIA**

Bosch  
2911235700  
2433456035  
Lucas / Delphi  
7169-60  
Deutz  
300-1744  
111-9231  
992-8367

BP 129/6

8 x 1 mm



Doble, para unión descarga

**SCANIA**

Deutz  
121-6492

BP 129/7

6 x 1 x 15 mm



Para descarga de inyector

**SCANIA**

Bosch  
2433314120  
2433314256  
Cummins  
3905307

BP 129/9

10 x 1 mm



Varias aplicaciones

**SCANIA**

Bosch  
2 911 201 701

BP 129/16

14 x 1.5 mm



Varias aplicaciones

**SCANIA**

Bosch  
2 911 201 703  
Fiat  
705737  
Deutz  
111-9243

BP 129/17

14 x 1.5 mm



Varias aplicaciones

**SCANIA**

Deutz  
121-6493  
Iveco  
1570211

BP 129/18

14 mm



Para filtro interior (sin filtro)

**SCANIA**

Bosch  
2 443 456 018  
Zexel  
152300-0920

BP 129/18A

14 x 1,5 mm



Para filtro interior

**SCANIA**

Bosch  
2 443 456 018  
Zexel  
152300-0920

BP 129/19

14 mm



Para prefiltro

**SCANIA**

Bosch  
2 911 205 703  
Fiat  
763 153

BP 129/20

16 x 1.5 mm



Aplicaciones varias

**SCANIA**

Bosch  
2 911 201 705

BP 129/21

18 mm



Aplicaciones varias

**SCANIA**

Fiat  
746 991

REPUESTOS

**BP 129/22**

20 mm



Aplicaciones varias

SCANIA

**BP 129/23**

22 x 1.5



Aplicaciones varias

SCANIA

**BP 129/24**

24mm



Aplicaciones varias

SCANIA

REPUESTOS

**BA 130/11**



**Bosch**  
0440011007

Bombita de llenado de circuito

SCANIA

**BA 130/11A**



**Bosch**  
0440011009

Bombita de llenado de circuito

SCANIA

**BA 130/11H**



**Bosch**  
0440011010

Bombita de llenado de circuito con cebador de hierro y con resorte

SCANIA

**BA 130/12**



**Bosch**  
0440011011

Bombita de llenado de circuito con pre-filtro

SCANIA

**BA 130/13**



**Bosch**  
42023436

Bombita de llenado de circuito con prolongador CD 139/19

SCANIA

**BA 130/24**



<b>Bosch</b>	<b>KHD</b>	<b>Volvo</b>
0 440 008 007 - FP/K 22 P9	0768702	1699140
0 440 008 998 - FP/K 22 P22	12034285	243083
0 440 008 029 - FP/K 22 P31	12038254	240072
0 440 008 037 - FP/K 22 P39	1173764	244391
0 440 008 045 - FP/K 22 P46	9981532	7243083
0 440 008 048 - FP/K 22 P51	4140419	Scania
0 440 008 020 - FP/K 22 P22	Flat Allie	319789
0 440 008 052 - FP/K 22 P58	71105310	211005
0 440 008 993 - FP/K 22 P58	768702	243083
0 440 008 004 - FP/K 22 P6	74061644	Magirus Deutz
Mercedes Benz	75204008	9981532
001 091 67 01	79026637	7981171
000 090 05 50	9981532	
001 091 78 01...		

Bomba alimentadora para bomba T/P sin filtro

SCANIA 111/112/113

**BA 130/24P**

E/S M14 X 1.5



**Bosch**  
0 440 008 004 FP/K22P6  
0 440 008 048 FP/K22P51  
**Mack (USA)**  
9350440008004  
**Scania**  
523 260 Ref. BCD  
**Volvo**  
240072 5008 5004

Bombita alimentadora para bomba T/P con pre-filtro

SCANIA 111/112

**BA 130/25**

1/4" x 18 NPTF



<b>Bosch</b>	<b>Renault (RV)</b>	<b>KHD</b>
0 440 008 003	500058510	1260836
0 440 008 014	50058510	1262033
0 440 008 035	5001832885	1287495
0 440 008 046	Magirus Deutz	0769096
0 440 008 017 FP/K22 P19		
0 440 008 033 FP/K22 P15		
0 440 008 040 FP/K22 P42		
Mercedes Benz	Hanomag	
2099965M91		
001 091 61 01	Steyr	
001 091 25 01	614080719	
000 090 03 50	551440008003	
Iveco	Man	
750696	81121016022	
93159106	5112017009	
DAF	90801112114	
2420070		
12A6869		

Bombita alimentadora para bomba T/P con pre-filtro

SCANIA 111

**BA 130/26**



**Bosch**  
0440008068  
**Volvo**  
244825  
3830076  
**Iveco**  
71445067 FP/KG 24 P 200  
8092471  
**Scania**  
1307770  
**KHD**  
4188108

Bombita alimentadora con cuerpo de aluminio

SCANIA 112 / 113 (200 Y 250 HP)

**BA 130/27**



**Bosch**  
0440008108 FP/KG 24P 311

Bombita alimentadora con cuerpo de aluminio

SCANIA 113 - BOMBA 7100

**BA 130/36**



<b>Bosch</b>	<b>KHD</b>
0 440 001 006	1287462
0 440 001 007	8122245
0 440 001 022	1287463
Mercedes Benz	Hanomag
000 091 65 01	197942706
<b>Volvo</b>	506686000
2382222-77988	Renault
<b>MWM</b>	0025838017
60520204003	0003020500
<b>MAN</b>	0854310800
1121508002	FP/K 22 BC 47
<b>Iveco</b>	FP/K 22 BC 47/2
9922392	FP/K 22 BC 135

Bomba alimentadora para bomba T/B sin filtro

SCANIA

**BA 130/36P**



M14x1.5

<b>Bosch</b>	<b>FP/K22BC48</b>	<b>Volvo</b>
0 440 001 009		2380098
0 440 001 037	FP/K22BC161	Renault (RV)
0 440 001 038	FP/K22BC175	7701009567
0 440 001 074	FP/K22BC236/2	Iveco
Mercedes Benz		742676
0000911601		Saurer
0000918001		1130843402
KHD/Deutz		Faun
01287466		0794616
01298719	Ref. BCD	
01301806	5001-5009	

Bomba alimentadora para bomba T/B con pre-filtro

SCANIA 111/112

REPUESTOS

### BA 130/47



**Bosch**  
0440008089  
0440008198  
**Volvo**  
863474  
**Scania**  
1307770  
**Man**  
51121017121  
**DAF**  
1339048

Pin 028-13,5mm

FP/KG 24 P 307

Bomba alimentadora

**SCANIA 124**

### BA 130/54V



**Bosch**  
0 440 008 008  
0 440 008 077  
0 440 008 090  
0 440 008 114  
0 440 008 116  
**MWM**  
605202030033  
**Scania**  
1123841

M14x1.5

FP/KD 22 P80 - 80I  
P89 - P90 - P10 - P85

Bomba alimentadora de cuatro válvulas

**SCANIA**

### BA 130/55V



**Bosch**  
0 440 008 015  
0 440 008 009  
**Iveco**  
7681171  
**Scania**  
211005-319789  
**Mercedes Benz**  
001 091 67 01  
000 090 05 50  
FP/K 22 P 17  
FP/K 22 P 11

Bomba alimentadora

**SCANIA**

### BA 130/56V



**Bosch**  
0 440 008 005  
0 440 008 028  
0 440 008 031  
0 440 008 039  
0 440 008 053  
0 440 008 118  
0 440 008 996  
FP/KD 22 P30 - P33  
P41 - P59 - P91 -  
P8 - P32

Roscas Entrada y salida:  
14 X 1,5

**Zexel**  
105237-4180

Bomba alimentadora

**SCANIA**

### BA 130/61



**Bosch**  
9440037000  
9440030018  
**Scania**  
347102  
**KHD**  
0170173910  
1261132

**Steyr**  
81560080036

FP/KD 22 P24  
FP/KD 22 P52-1

Bomba alimentadora de cuatro válvulas

**SCANIA - KHD - STEYR**

### BA 130/62



**Bosch**  
0440008113  
0440008137  
**Scania**  
1422627  
1744064  
**Cummins**  
3092731

PIN 028 - 13,5mm  
M14x1,5

FP/KG 24 P 314  
Ref.BCD  
52081113

Bomba alimentadora

**SCANIA 9.0L ESTACIONARIOS**  
S4DC/DSC9/11.0L

### BA 130/63



**Bosch**  
0440008092  
**Man**  
51121017075  
51121017107  
FP/GK 24 P 210

PIN 024-11,5mm

Bomba alimentadora

**MAN - SCANIA**

### BA 130/64



**Bosch**  
0440008084  
**Man**  
51121017081  
51121017106  
FP/KG 24 P304

PIN 028-13,5mm

Bomba alimentadora

**MAN - SCANIA**

### BA 130/93



**Bosch**  
0440 020 057  
0440 020 128  
**Scania**  
1539298

Bomba alimentadora

**SCANIA SERIE 4 - SERIE P/G/R/T**

### BA 130/96



**Bosch**  
0440020129  
0440020058  
0440020010  
FP/ZP17H/R1S  
**Scania**  
1536255

Bomba alimentadora

**SCANIA DC16 - 15.0L / 16.0L**

REPUESTOS

### BA 130/209



**Scania**  
1518142 , 804670 , 2081828  
1430067 , 1373793 , 1440235  
1852161 , 813198 , 1737657  
1745730 , 1731092 , 1514998  
760709 , 1760708 , 809809  
809820 , 802998  
**MAN**  
51471040024

Bomba de combustible

**SCANIA P/G/R/T BUS 4- / F- / F- SRIES**  
MOTOR DC12

### BA 130/216



**Scania**  
2059884  
2477223

Bomba de combustible

**SCANIA MOTOR DC13**

### BA 130/219



**Scania**  
3063789  
P4384252

Bomba alimentadora de combustible de baja DMB  
para 2836838 2478832

**SCANIA SERIE L/P/G/R/S DC13**

REPUESTOS

**BA 130/500**



Scania  
1789522  
1787120

Bomba de agua - Serie 4  
**SCANIA SERIE P/G/R/T**  
MOTOR DC9 DC11 DT12

**BA 130/501**



Scania  
1789555  
1778923  
1884327

Bomba de agua  
**SCANIA SERIE P/G/R/T**  
MOTOR DC13 DC-DSC9

REPUESTOS

**RT 132/2**



Bosch  
V61183

Reten fuelle cremallera de bomba P

**SCANIA VABIS**

**RT 132/3**



Bosch  
2 420 451 001

Fuelle para eje TPS

**SCANIA 111/112**

**CA 132/4**



Scania  
02922811

De goma para tapa de válvula

**SCANIA 113**

REPUESTOS

**CM 133/1**



Bosch  
2 447 222 000  
Iveco  
774 417

Corto

**MERCEDES BENZ - HANOMAG - DEUTZ - IVECO**

**CM 133/1R**



NP  
155200-1120

Corto con resorte tipo Nippon Denso

**MERCEDES BENZ - HANOMAG - DEUTZ - IVECO**

**CM 133/2**



Bosch  
2 447 222 001  
Iveco  
748 959

Largo

**FIAT - VOLVO - MACK**

**CM 133/2R**



NP  
155200-1120

Largo con resorte tipo Nippon Denso

**FIAT - VOLVO - MACK**

**CM 133/7**



Bosch  
2 447 222 125

Cebador capuchon. Modelo Nuevo

**MERCEDES BENZ - SCANIA**

REPUESTOS

**1**

<b>CF 138/1</b>	5 x 9 mm
<b>CF 138/2</b>	8 x 12 mm
<b>CF 138/3</b>	9,5 x 14 mm
<b>CF 138/7</b>	6 x 10 mm
<b>CF 138/8</b>	13 x 18 mm
<b>CF 138/9</b>	16 x 24 mm

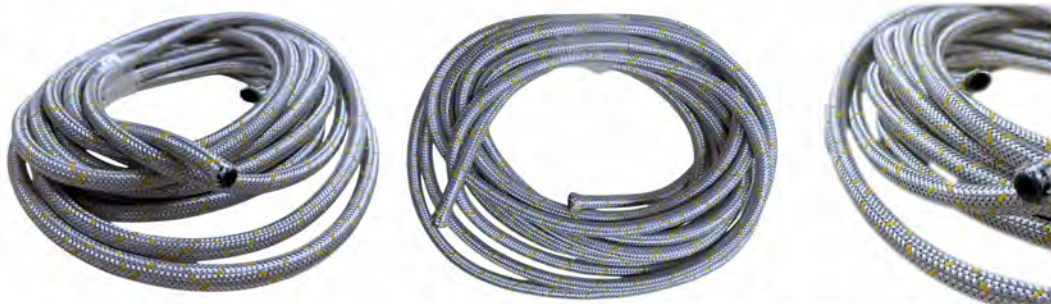
**En rollo de 10 metros**

REPUESTOS

**1**

<b>CC 138/20</b>	3 x 6 mm
<b>CC 138/22</b>	4 x 7 mm
<b>CC 138/23</b>	4 x 8 mm
<b>CC 138/24</b>	6 x 10 mm
<b>CC 138/25</b>	6 x 11 mm
<b>CC 138/26</b>	6 x 12 mm
<b>CC 138/27</b>	7 x 12 mm
<b>CC 138/28</b>	7 x 14 mm
<b>CC 138/29</b>	8 x 12 mm
<b>CC 138/30</b>	8 x 14 mm
<b>CC 138/31</b>	9 x 16 mm

**En rollo de 50 metros**

REPUESTOS

**1**

<b>CH 138/35</b>	3 x 6 mm
<b>CH 138/36</b>	4 x 7 mm
<b>CH 138/37</b>	4 x 8 mm
<b>CH 138/38</b>	6 x 10 mm
<b>CH 138/39</b>	6 x 12 mm
<b>CH 138/40</b>	7 x 11 mm
<b>CH 138/41</b>	7 x 12 mm
<b>CH 138/42</b>	7 x 14 mm
<b>CH 138/43</b>	8 x 14 mm
<b>CH 138/44</b>	9 x 6 mm

**En rollo de 50 metros**

REPUESTOS

<b>CP 138/50</b>	4 x 6 mm	Retorno de combustible
<b>CP 138/51</b>	6 x 8 mm	Lubricación de aceite
<b>CP 138/52</b>	7 x 10 mm	Combustible
<b>CP 138/53</b>	8 x 11 mm	Aire y Combustible
<b>CP 138/54</b>	9 x 12 mm	Aire
<b>CP 138/54A</b>	11 x 14 mm	Aire
<b>CP 138/55</b>	12 x 16 mm	
<b>CP 138/55B</b>	14 x 18 mm	
<b>CP 138/56</b>	Ø Int 1/4"	
<b>CP 138/57</b>	Ø Int 3/8"	
<b>CP 138/58</b>	Ø Int 1/2"	
<b>CP 138/59</b>	Ø Int 5/8"	



En rollo de 50 metros

REPUESTOS

<b>CT 138/63</b>	3 x 7 mm
<b>CT 138/64</b>	4 x 8 mm
<b>CT 138/65</b>	5 x 9,5 mm
<b>CT 138/66</b>	6 x 12 mm
<b>CT 138/67</b>	7 x 12 mm
<b>CT 138/68</b>	8 x 13 mm
<b>CT 138/69</b>	9 x 15 mm

En rollo de 50 metros

En rollo de 25 metros



REPUESTOS

<b>CG 138/70</b>	3 x 7 mm
<b>CG 138/70A</b>	4 x 8 mm
<b>CG 138/70B</b>	5,5 x 9 mm
<b>CG 138/70C</b>	6 x 12 mm
<b>CG 138/70D</b>	8 x 13 mm



En rollo de 50 metros

REPUESTOS

**CD 139/19**

 Macho: M14X1,5  
 Hembra: M14x1,5

**ADAPTADOR**

Prolongador para bombita de llenado de circuito universal

**SCANIA**
**CD 139/19A**

 Macho: M20x1,5  
 Hembra: M14x1,5

Conexión prolongador para bomba auxiliar (de llenado de circuito)

**SCANIA**
**CD 139/38**

M12x1,5 - 8 mm

 Scania  
 2220509

Conector racord recto con vástago para purga de aire

**SCANIA DC09/DC13/DC16 SERIE 6**
**CD 139/39**

M12x1,5- Diam. interno M8x1

 Scania  
 1490086

 Conector acoplamiento rápido metálico para aire.  
 Para MV 2090/2091/2092

**SCANIA DC09/DC13/DC16**

REPUESTOS

**CI 140/107**

**Bosch**  
 0431204016  
 KBL112S28/13  
 Scania  
 211977  
 211997

Cuerpo de inyector completo sin tobera

**SCANIA 76/110/111 MOTOR DS11**
**CI 140/107A**

**Bosch**  
 0431214997  
 KBEL109S6/13  
 Scania  
 257228

Cuerpo de inyector completo sin tobera

**SCANIA 112 MOTOR DS11  
 82/86 MOTOR DS18**
**E 146/101**

Espiga para inyector HPI

**SCANIA DC12/DT12 CUMMINS ISX/QSX**
**DI 143/51**

**Bosch**  
 2 420 503 002

Diafragma para TPS

**SCANIA**

REPUESTOS

**EF 150/50B**

 Diametro: 110 mm  
 Altura: 115 mm  
 Paso: Ø 22, Ø 17

**Racor**  
 900FG  
 2040PM

Elemento filtrante tipo Racor para FC 151/50B

**SCANIA**
**EF 150/55**

**Mercedes Benz**  
 457 09200 01  
**Racor**  
 R 90-30MB  
 A: 109mm  
 B: 88 mm  
 C: 101 mm  
 G: 1" x 12 Hilos  
 H: Largo 144 mm  
 Largo con rosca vaso 160 mm

con rosca para filtro racor - br-90hm - para FC 151/46

**SCANIA**
**EF 150/56**

**Racor**  
 R 60-10M  
 A: 109 mm  
 B: 80 mm  
 C: 90 mm  
 G: 1" x 14 Hilos  
 H: Largo 120 mm  
 Largo con rosca vaso 130 mm

con rosca para filtro racor - br-60hm para FC 151/47 y /47A

**SCANIA**



REPUESTOS

**EF 150/56P**

CON VASO PLASTICO



Racor R 60-10M

con rosca para filtro racor - br-60hm para FC 151/47 y /47A

**SCANIA - IVECO - FORD CARGO**

**EF 150/62**



Man WK1060/1  
Scania 1393640  
Volvo 81599755

Elemento filtrante con vaso plástico tipo Racor

SCANIA P/R/T 114, 124P 94 - CATERPILLAR 3116  
VOLVO FH12, NH12, NI12 BUSES B7R-230, B7R-280

**EF 150/64x2**



Scania 2779191  
1794863  
1865227  
1736248  
1736250  
2003505  
1920628

Elementos filtrantes de combustibles [2 unidades] PU10003-2x  
Kit PU10007 + PU9004 (con junta)

**SCANIA SERIES G / P / R / K310  
DC09 - DC13**



REPUESTOS

**EF 150/201-R**



Mercedes Benz	Iveco	MAN
A0004300969	2992261	81521086001
A0004300669	01907612	81521020008
A0004393395	08123564	81521020009
A0004291097	08190948	81521020010
A0004293695	Renault	81521020013
A0004293795	5000295421	81521020019
A0004293595	5001004902	81521020015
A0004291297	7421267820	82521020013
Scania	5001832112	99100360822
1111131	Evobus	John Deere
1375997	8285141196	A1204884
377640	Hyundai	Wabco
Tecfil	95680 7R000	4324100202
DSF0202		4329980202

Filtro secador de aire de freno DMB - Rosca derecha

**SCANIA SERIE 3**

**EF 150/202**



Wabco	Scania
4324102262	1348549
DAF	1455253
1504935	1744598
1523992	1774598
1527759	1932690
MAN	2081360
N2509990182	2307617
Renault	2562323
5001843522	5021170077
5021170077	57142020
7485137862	

Filtro secador de aire de freno DMB

SCANIA 140L G320LB/G360LB/G440EURO6/G450CB  
G94/R94/T114/T124/T144



REPUESTOS

**FC 151/35**



Entrada derecha con rosca de 14 x 1.5 mm

Filtro de combustible con unidad sellada

**DEUTZ - SCANIA**

**FC 151/36**



Entrada y salida de rosca de 14 mm x 1.5

Filtro de combustible simple

**DEUTZ - SCANIA - UNIVERSAL**

**FC 151/36B**



Rosca de 1/8 gas p/ manguera

Filtro de combustible simple

**DEUTZ - SCANIA - VS**

**FC 151/37**



Entrada y salida de rosca de 14 mm x 1.5

Filtro de combustible doble con unidad sellada

**SCANIA 111 / 112 - VS**

**FC 151/46**

Rosca 1" - 12 hilos Ent y sal M14x1,5



Mercedes Benz 4760907452  
Racor 690-10HP

P/PURG= M21x1,25-6h

Filtro de combustible tipo Racor

**SCANIA P94/114/124/OMNIBUS 114/124**

**FC 151/46P**



Rosca 1" - 12 hilos Ent y sal M14x1,5

CON VASO PLASTICO  
Mercedes Benz 4760907452  
Racor 690-10HP

Filtro trampa de agua tipo Racor

**SCANIA P94/114/124/OMNIBUS 114/124**

**FC 151/47**

R=1"-14h / E/S=M14x1,5



Scania 523901

P/PURG= M21x1,25-6h

Filtro de combustible tipo Racor

SCANIA CAMIONES Y OMNIBUS - FORD CARGO 14000  
CAMION C/MOTOR CUMMINS - M.BENZ OM366A  
CAMIONES 1620/1218 - IVECO EUROCARGO/BRASIL

**FC 151/47P**

R=1"-14h / E/S=M14x1,5

**FC 151/47AP**

R=1"-14h / E/S=M16x1,5



Scania 523901

Filtro de combustible tipo Racor

**SCANIA CAMIONES Y OMNIBUS  
CAMION C/MOTOR CUMMINS**

**FC 151/50B**

Entrada y Salida 7/8" - 14



Racor 900FG

Filtro armado de combustible tipo Racor

**VOLVO - SCANIA**

REPUESTOS

**FC 151/50C**



**Racor**  
1000FG

Filtro armado de combustible tipo Racor

**VOLVO - SCANIA**

**FC 151/53**



Rosca filtro: 1"-14  
Entrada y salida: M14x1,5

**Mann**  
WK1060/1  
**Scania**  
1393640  
**Caterpillar**  
81599755

Filtro trampa de agua armada tipo Racor R90P

SCANIA P/R/T 114, 124P94 - CATERPILLAR 3116  
VOLVO Fh12, Nh12, Ni12 BUSES B7R-230, B7R-280

REPUESTOS

**FM 152/1**



**Bosch**  
1450410011

Metálico - De vasito bombita alim. y prefiltro t/ Bosch  
**MERCEDES BENZ - FIAT - DEUTZ**  
**SCANIA - VOLVO - VS**

**FM 152/3**



**Bosch**  
1450410011

Plástico - de vasito bombita alim. y prefiltro t/ Bosch  
**MERCEDES BENZ - FIAT - DEUTZ**  
**SCANIA - VOLVO - VS**

**FM 152/22**



R= M22 x 1.5 mm

Filtro para tanque de aire  
**MERCEDES BENZ**

**FM 152/23**



Filtro de tanque de aire de freno "VOLTEO"

**MERCEDES BENZ**

**FM 152/101**



**Scania**  
1421174  
ED3087316  
**Cummins**  
3348004

Filtro blanco DMB para inyector HPI

**SCANIA DC12 / DT12 CUMMINS ISX/QSX**

**FM 152/102**



Filtro negro DMB para inyector HPI

**SCANIA DC12 / DT12 CUMMINS ISX/QSX**

REPUESTOS

**JR 155/60**



Ref. 1 1-JUN 156/66A (2 440 109 005)  
Ref. 2 1-FM 152/3 (1 450 410 011)  
Ref. 3 1-RB 180/3 (2 454 642 000)  
Ref. 4 1-VAS 225/21L (2 459 999 002)

**Bosch**  
2 447 010 017

Kit de reparación para bomba alimentadora tipo Bosch con vaso liso

**VS**

**JR 155/61**



**Bosch**  
2447010032

Kit vaso plástico modelo nuevo para bombita alimentadora tipo Bosch

**MERCEDES BENZ**

**JR 155/64**

Diam. 6 mm



Conjunto de reparación de emergencia para mangueras de poliamida

**VS**

**JR 155/65**

Diam. 8 mm



Conjunto de reparación de emergencia para mangueras de poliamida

**VS**

**JR 155/66**

Diam. 11 mm



Conjunto de reparación de emergencia para mangueras de poliamida

**VS**

**JR 155/67**

Diam. 12 mm



Conjunto de reparación de emergencia para mangueras de poliamida

**VS**

REPUESTOS

**JR 155/79**



**Bosch**  
2 447 010 011

- Ref. 1 2-RB 180/4 (2 444 615 004)
- Ref. 2 2-VAL 222/1 (2 443 123 021)
- Ref. 3 2-AC 115/2 (1 230 203 001)

Kit de reparación para bomba alimentadora tipo Bosch

VS

**JR 155/81**



**Bosch**  
9 441 080 020

- Ref. 1 4-AC 115/24 (2 916 710 610)
- Ref. 2 2-AC 115/2 (1 230 203 001)
- Ref. 3 1-JUN 156/66 (2 440 109 005)
- Ref. 4 1-SV 190/1 (2 444 601 000)
- Ref. 5 3-AG 105/1 (2 916 690 005)
- Ref. 6 1-AG 122/75 (1 900 210 100)
- Ref. 7 1-AC 115/1 (2 440 105 000)
- Ref. 8 2-RB 180/4 (2 444 615 006)
- Ref. 9 2-VAL 222/1 (2 443 123 021)

Kit de reparación para bomba alimentadora tipo Bosch

VS

**JR 155/82**



**Bosch**  
9 441 080 175

- Ref. 1 4-AC 115/24 (2 916 710 610)
- Ref. 2 3-AG 105/1 (2 916 690 005)
- Ref. 3 2-VAL 222/1 (2 443 123 021)
- Ref. 4 2-RB 180/4 (2 444 615 006)
- Ref. 5 2-VAL 222/1 (2 443 123 021)
- Ref. 6 1-JUN 156/66A (2 440 109 005)
- Ref. 7 1-AG 122/75 (1 900 210 100)
- Ref. 8 1-AC 115/1 (2 440 105 000)

Kit de reparación para bomba alimentadora tipo Bosch

VS

**JR 155/83**



**Bosch**  
2 447 010 016  
2 447 010 003

- Ref. 1 1-JUN 156/66A (2 440 109 005)
- Ref. 2 1-FM 152/1 (1 450 410 011)
- Ref. 3 1-RB 180/3 (2 454 642 000)

Kit de reparación para bomba alimentadora tipo Bosch y prefiltro tipo Bosch

VS

**JR 155/84**



**Bosch**  
2 447 010 004

- Ref. 1 2-AC 115/2 (1 230 203 001)
- Ref. 2 1-AG 122/75 (1 900 210 100)
- Ref. 3 2-VAL 222/1 (2 443 123 021)
- Ref. 4 2-RB 180/4 (2 444 615 006)
- Ref. 5 4-AC 115/24 (2 916 710 610)
- Ref. 6 1-JUN 156/1 (1 411 073 002)
- Ref. 7 1-AC 115/1 (2 440 105 000)
- Ref. 8 1-SV 190/1 (2 444 601 000)

Kit de reparación para bomba alimentadora tipo Bosch

VS

**JR 155/84A**



**Bosch**  
2 447 010 004

- Ref. 1 2-AC 115/2 (1 230 203 001)
- Ref. 2 1-AG 122/75 (1 900 210 100)
- Ref. 3 2-VAL 222/1 (2 443 123 021)
- Ref. 4 2-RB 180/4 (2 444 615 006)
- Ref. 5 4-AC 115/24 (2 916 710 610)
- Ref. 6 1-JUN 156/1 (1 411 073 002)
- Ref. 7 1-AC 115/1 (2 440 105 000)
- Ref. 8 1-SV 190/1 (2 444 601 000)
- Ref. 9 4-CO 105/11
- Ref. 10 3-AG 105/1 (2 916 699 083)
- Ref. 11 1-AG 122/74 (2 440 210 009)
- Ref. 12 2-CP 134/10 (1 900 508 008)

Kit de reparación para bomba alimentadora tipo Bosch

VS

**JR 155/85**



**Bosch**  
2 447 010 004Z

- Ref. 1 1-VAS 225/21L (2 459 999 002)
- Ref. 2 1-RB 180/3 (2 454 642 000)
- Ref. 3 1-FM 152/1 (1 450 410 011)
- Ref. 4 1-RB 180/3 (2 454 642 000)
- Ref. 5 1-JUN 156/1 (1 411 073 002)
- Ref. 6 1-AG 122/75 (1 900 210 100)
- Ref. 7 1-SV 190/1 (2 444 601 000)
- Ref. 8 4-AC 115/24 (2 916 710 610)
- Ref. 9 2-AG 105/1 (2 916 690 005)
- Ref. 10 2-VAL 222/1 (2 443 123 021)
- Ref. 11 2-AC 115/2 (1 230 203 001)
- Ref. 12 2-RB 180/4 (2 444 615 006)
- Ref. 13 1-AC 115/1 (2 440 105 000)

Kit de reparación para bomba alimentadora tipo Bosch

VS

**JR 155/86**



**Bosch**  
2 447 010 004S

- Ref. 1 1-VAS 225/21L (2 459 999 002)
- Ref. 2 1-RB 180/3 (2 454 642 000)
- Ref. 3 1-FM 152/1 (1 450 410 011)
- Ref. 4 1-JUN 156/66 (2 440 109 005)
- Ref. 5 1-CM 135/10 (2 447 222 016)
- Ref. 6 1-SV 190/1 (2 444 601 000)
- Ref. 7 2-AC 115/2 (1 230 203 001)
- Ref. 8 3-AG 105/1 (2 916 690 005)
- Ref. 9 2-VAL 222/1 (2 443 123 021)
- Ref. 10 2-RB 180/4 (2 444 615 006)
- Ref. 11 4-AC 115/24 (2 916 710 610)
- Ref. 12 1-JUN 156/1 (1 411 073 002)
- Ref. 13 1-AG 122/75 (1 900 210 100)
- Ref. 14 1-AC 115/1 (2 440 105 000)

Kit de reparación para bomba alimentadora tipo Bosch y prefiltro tipo Bosch

VS

**JR 155/87**



**Bosch**  
1 457 434 000

- Ref. 1 1-VAS 225/21L (2 459 999 002)
- Ref. 2 1-RB 180/3 (2 454 642 000)
- Ref. 3 1-FM 152/1 (1 450 410 011)
- Ref. 4 1-JUN 156/66 (2 440 109 005)
- Ref. 5 1-SV 190/9 (9 441 060 033)
- Ref. 6 4-AC 115/24 (2 916 710 610)
- Ref. 7 1-TV 194/2 (2 459 999 001)
- Ref. 8 2-BP 129/16 (2 916 210 610)

Kit de reparación para bomba alimentadora tipo Bosch

VS

**JR 155/89**



De bba. P. contiene 4 laminas, 4 bujes, y 4 arandelas planas.

**MERCEDES BENZ 1526**

**JR 155/89/AC**



ACERO REFORZADO

De bba. P. contiene 4 laminas, 4 bujes, y 4 arandelas planas.

**MERCEDES BENZ 1526**

**JR 155/90**



De bba. P. contiene 4 laminas, 4 bujes, y 4 arandelas planas.

**SCANIA 112**

**JR 155/90AC**



ACERO REFORZADO

De bba. P. contiene 4 laminas, 4 bujes, y 4 arandelas planas.

**SCANIA 112**

**JR 155/91**



De bba. P. contiene 6 laminas, 6 bujes, y 6 arandelas planas.

**SCANIA 113**

**JR 155/91AC**



ACERO REFORZADO

De bba. P. contiene 6 laminas, 6 bujes, y 6 arandelas planas.

**SCANIA 113**

**JR 155/98**



Kit con tapón de 22mm con válvula T/M p bomba alim.

**SCANIA**

**JR 155/99**



Kit con tapon de 24mm con válvula T/M p Bomba Alim.

**MERCEDES BENZ**

**Mercedes Benz**  
A0000900810  
**Bosch**  
2447010024  
2447010043

REPUESTOS

**JR 155/311AG**

Ref. Original  
Scania  
1422564

Bosch  
F00VX99999

AG 122/600

AG 122/601

AG 122/602



Kits de Oring's para inyector bomba sistema PDE

**SCANIA SERIE 4**

REPUESTOS

**JUN 156/1**



Bosch  
1411073002

Para bomba de acople bombita tipo "A"

VS

**JUN 156/8**



Bosch  
1411073000  
1411073004

Para base de bomba alimentadora Tipo A mod. Nuevo Angosta

VS

REPUESTOS

**JUN 156/66A**



Bosch  
2440109005

De vasito tipo Bosch goma gruesa

VS

REPUESTOS

**JUN 156/355T**



Juego de junta para turbo

SCANIA 111/112 - MERCEDES BENZ 1526 OM355/6  
TV6114/4LGZ/4LE

**JUN 156/449T**



Juego de junta para turbo

SCANIA 133 - MERCEDES BENZ 1630/1633 OM447/449  
TA45/GT45/S400

REPUESTOS

**LA 158/4**  
COMUN

**LA 158/4/AC**  
ACERO  
REFORZADO

Bosch  
1 410 136 005

Lamina de acople  
SCANIA VABIS - CHEVROLET 350 - DEUTZ  
MOTOR NISSAN 165/205 - ISUZU 6BD1 - HINO

**LA 158/10**  
COMUN

**LA 158/10/AC**  
ACERO  
REFORZADO

Volvo  
417512

Lamina de acople grande super 110  
SCANIA GRANDE SUPER 110/VOLVO B58/B10M  
C/MOTOR THD 100 EC/THD121GB/THD101KC/THD101G

**LA 158/11**  
COMUN

**LA 158/11/AC**  
ACERO  
REFORZADO

MWM  
Bosch 606904030002  
1 410 136 007  
3 410 190 503  
Volvo 457512

Lamina de acople grande  
SCANIA VABIS L-111 - MERCEDES BENZ 1526  
OM 355-5 / OM 355-6 - VOLVO LINEA NL

**LA 158/13**  
COMUN

**LA 158/13/AC**  
ACERO  
REFORZADO

Bosch 2 411 098 074  
Scania 392204

Lamina de acople cuadrada  
SCANIA 112

**LA 158/15**  
COMUN

**LA 158/15/AC**  
ACERO  
REFORZADO

Bosch  
3 410 190 500

Lamina de acople ondulada  
SCANIA 113

REPUESTOS

**MA 159/7**

Tipo original  
SCANIA VABIS

**MA 159/10**

De bomba brasilera  
YUGO - SCANIA VABIS 110/111

Scania  
005073

**MA 159/11**

Tipo original  
SCANIA 112

Scania  
340273

REPUESTOS

**LE 159/50**

PARA ESCRIBIR O MARCAR EN:  
Superficies cementadas  
Metales de alta dureza  
Aceros templados  
Herramientas  
Calibres  
Tensión 220 V-50 C  
Potencia 400 Va

Lápiz eléctrico  
VS

**LE 159/50A**

Punta para lápiz eléctrico  
VS

**MIA 159/101**

Agilise antes de usar  
CONTENIDO NETO 60 cm<sup>3</sup>  
INDUSTRIA ARGENTINA

Trazo 1/8" - Color amarillo

Contenido Neto **60** cm<sup>3</sup>

Para marcar, numerar y codificar todo tipo de metales plásticos, maderas, gomas, cerámicas, etc. Escribe inclusive sobre superficies aceitosas y rústicas, resiste temperatura e intemperie. Provisto en envase de plástico, flexible, anatómico.

**MARCADOR INDUSTRIAL - PINTURA PARA PRECINTO**

REPUESTOS

**PLQ 164/9**

18 x 5



<b>Bosch</b>	<b>M.Benz</b>
2430136166	0010177252
<b>Iveco</b>	<b>Scania</b>
9941816	395767
<b>Deutz</b>	<b>Volvo</b>
1321088	1698513

De inyector

**SCANIA 113 MOTOR DSC11**

**PLQ 164/12**

18 x 7



<b>Bosch</b>	<b>MWM</b>
2430136085	606907251405
2430136007	<b>Iveco</b>
<b>Scania</b>	42490269
269785	<b>Volvo</b>
	846292

De inyector

**SCANIA 112**

REPUESTOS

**PREF 168/1**



**Bosch**  
1 457 434 000

Prefiltro

**SCANIA**

**PREF 168/1A**



**Bosch**  
2 457 434 009

Prefiltro - Modelo nuevo con vaso plastico

**SCANIA**

REPUESTOS

**PT 170/6**



**Bosch**  
2 433 314 057

Portatobera

**SCANIA VABIS L-111**  
DLLA150S615 - DLLA150S616

**PT 170/20**



**Bosch**  
2 433 314 023  
2 433 349 213

Portatobera

**SCANIA VABIS L-112**  
DLLA150S853

**PT 170/39**



**Bosch**  
2 433 349 472

Portatobera

**SCANIA 112 TURBO / INTERCOOLER**  
DLLA46P154

**PT 170/47**



**Bosch**  
2 433 314 042

Portatobera

**SCANIA 113 INY BOSCH INTERCOOLER**  
DLLA155P230 - DLLA155P306 - DLLA142P221

**PT 170/72**



**Bosch**  
2 433 349 304

Portatobera para inyección doble etapa

**SCANIA 114/124**

REPUESTOS

**RAC 173/27**



**Bosch**  
2433370035  
**Scania**  
275368

De tubo de presión, entrada de inyector

SCANIA 112 MOTOR DS11 - 82/86 MOTOR DS18

**RAC 173/28**



**Bosch**  
2433370110  
**Scania**  
193567

De tubo de presión, entrada de inyector

SCANIA 76/110/111 MOTOR DS11

**RAC 173/33**

20x1,5 / 14x1,5



De entrada bomba llenado - Racord reductor

SCANIA

**RAC 173/38**

M22



**Bosch**  
2 443 461 003

Racord tapón con válvula para bomba alimentadora

BOMBAS SCANIA 0 440 008 074

**RAC 173/39**

M24



**Bosch**  
2 443 461 020  
**Iveco**  
9967629  
**Scania**  
1374596  
**Volvo**  
3094340

Racord tapón con válvula para bomba alimentadora

BOMBAS 0 440 008 072

0 440 008 079 - 0 440 008 089

REPUESTOS

**RB 180/1**



**Bosch**  
2 444 615 007

De botador de bomba alimentadora tipo Bosch (todas)

VS

**RB 180/2**



**Bosch**  
2 444 617 010

De botador de bomba alimentadora tipo Bosch (todas)

VS

**RB 180/3**



**Bosch**  
2 444 615 007  
**Iveco**  
772 161

De filtro para vaso de bomba y prefiltro tipo Bosch (todas)

VS

**RB 180/4**



**Bosch**  
2 444 615 006  
**Fiat**  
705 639  
**Iveco**  
772 127

De válvula de bomba alimentadora tipo Bosch (todas)

VS

REPUESTOS

**REL 185/5**

30x42x7



**Bosch**  
2 410 283 010

De bomba P con guardapolvo

FIAT - SCANIA 112

**REL 185/22**

35x47x7



**Bosch**  
2 410 283 018  
2 410 283 024

De bomba P con guardapolvo

SCANIA 113

**REL 185/101**



**Scania**  
1801418

Retén para inyector HPI

SCANIA DC12/DT12 CUMMINS ISX/QSX

REPUESTOS

SCI 188/8



3 Caños

MERCEDES BENZ 1114 - DEUTZ - VS

SCI 188/9



2 Caños

MERCEDES BENZ 1114 - DEUTZ - VS

SCI 188/14



4 Caños

MERCEDES BENZ - DEUTZ - IVECO  
SCANIA - FIAT - VS

Iveco  
4734007

SCI 188/15



6 Caños

MERCEDES BENZ - DEUTZ - IVECO  
SCANIA - FIAT - VS

Iveco  
4806614

SCI 188/18



5 Caños

MERCEDES BENZ - DEUTZ - IVECO  
SCANIA - FIAT - VS

REPUESTOS

SV 190/9



Bosch

9 441 080 033

Alambre ajuste vaso tipo original

MERCEDES BENZ

SV 190/16



Seguro para horquilla TPS Bosch

SCANIA

REPUESTOS

SO 191/39C

12 Volts



Cod. Original  
SA-3799-12

Solenoides de pare completo  
MOTORES ESTACIONARIOS  
SCANIA (Grupos Electrogenos)

SO 191/39CK

12 Volts

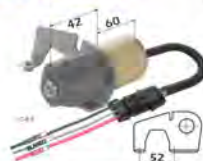

Woodward  
SA-3799-12

Solenoides de pare completo - corto  
MOTORES ESTACIONARIOS  
SCANIA (Grupos Electrogenos)

SO 191/40C

24 Volts



Cod. Original  
SA-3799-24

Solenoides de pare completo  
MOTORES ESTACIONARIOS  
SCANIA (Grupos Electrogenos)

SO 191/40CK

24 Volts

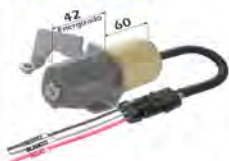

Woodward  
SA-3799-24

Solenoides de pare completo - corto  
MOTORES ESTACIONARIOS  
SCANIA (Grupos Electrogenos)

SO 191/88C

12 Volts



Solenoides de pare completo

SCANIA

SO 191/89C

24/28 Volts



Solenoides de pare completo

SCANIA

REPUESTOS

**SO 191/151**

24 Volts



**Bosch**  
2417213007  
Case  
9970198

Solenoid electroimán de empuje

**SCANIA 124**

**SO 191/151A**



**Bosch**  
2417205022  
Scania  
1370084  
Case  
9970197

Solenoid electroimán de empuje con carcasa de aluminio

**SCANIA 113 / 114 / 124**

**SO 191/151B**



**Bosch**  
2417205026  
Scania  
1368171

Solenoid electroimán de empuje con carcasa de aluminio

**SCANIA 94 MOTOR 9.0 L**

REPUESTOS

**TV 194/1**

R= 14 x 1.5



Tapa de prefiltro tipo Bosch modelo nuevo

**SCANIA**

**TV 194/2**

R= 14 x 1.5



**Bosch**  
2 459 999 001  
Iveco  
129 0638

Soporte prefiltro bomba alimentadora tipo Bosch

**VS**

**TV 194/34**

R = 14 x 1.5



Tapa duofiltro para unidad sellada

**SCANIA**

**TV 194/38**

Ent/Sal=14mm - Rosca 16x1,5

**TV 194/38A**

Ent/Sal=12mm - Rosca 16x1,5

**TV 194/38B**

Ent/Sal=1/8gas - Rosca 16x1,5

**TV 194/38C**

Ent/Sal= 1/2x20 - Rosca 3/4x16



Para filtro interior

**SCANIA**

**TV 194/44**

R = 1" - 12 hilos

Entrada y salida : M14x1.5



**M. Benz**  
376 092 7108

Tapa de filtro de combustible tipo Racor  
**SCANIA CAMIONES P94/114/124/OMNIBUS**  
114/124

**TV 194/45**

R = 1" - 14 hilos

Entrada y salida : M14x1.5

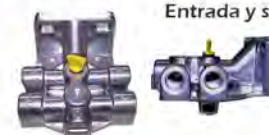

Tapa de filtro de combustible tipo Racor

**SCANIA CAMIONES Y OMNIBUS**

**TV 194/46**



Entradas frontales ciegas.  
Entrada y salida lateral rosca 14 x 1,5.  
Rosca macho p/armado de filtro 16 x 1,5.



**Scania**  
0525356

Tapa duofiltro para unidad sellada

**SCANIA**

REPUESTOS

**TOR 202/2**



**Bosch**  
1 413 453 020

Tipo Bosch con cabeza hexagonal

**VS**

**TOR 202/9**

Rosca 3/8" x 24h



**Perkins**  
001 901

De filtro, plástico

**PERKINS - DEUTZ**

REPUESTOS

**UN 217/1**

8 mm



Unión de acero - Con vástago

**SCANIA**

**UN 217/2**

8 mm



Unión de acero de doble salida

**SCANIA**

**UN 217/3**

8 mm



Unión de acero de doble salida en V

**SCANIA**

REPUESTOS

**UN 217/16**

12 mm



Con vástago de 7mm p/manguera o poliamida de 1/4" (6,35mm)

**VS**

**UN 217/17**

12 mm



Con vástago de 8,5mm p/manguera o poliamida de 8mm

**VS**

**UN 217/18**

12 mm



Con vástago de 9,5mm p/manguera o poliamida de 3/8" (8mm)

**VS**

**UN 217/19**

13 mm



Con vástago de 7mm p/manguera o poliamida de 1/4" (6,35mm)

**VS**

**UN 217/20**

13 mm



Con vástago de 8,5mm p/manguera o poliamida de 8mm

**VS**

**UN 217/21**

13 mm



Con vástago de 10mm p/manguera o poliamida de 3/8" (9mm)

**VS**

**UN 217/22**

14 mm



Con vástago de 7mm p/manguera o poliamida de 1/4" (6,35mm)

**VS**

**UN 217/23**

14 mm



Con vástago de 8,5mm p/manguera o poliamida de 8mm

**VS**

**UN 217/24**

14 mm



Con vástago de 10mm p/manguera o poliamida de 3/8" (9mm)

**VS**

**UN 217/25**

10 mm



Con vástago de 7,5mm p/manguera o poliamida de 1/4" (6,35mm)

**VS**

**UN 217/26**

12 mm



Con vástago de 7,5mm p/manguera o poliamida de 1/4" (6,35mm)

**VS**

**UN 217/27**

16 mm



Con vástago de 12mm p/manguera o poliamida de 1/2" (12,7mm)

**VS**

REPUESTOS

<b>UC 218/PE06</b>	Para Poliamida de 6 mm
<b>UC 218/PE08</b>	Para Poliamida de 8 mm
<b>UC 218/PE10</b>	Para Poliamida de 10 mm
<b>UC 218/PE12</b>	Para Poliamida de 12 mm
<b>UC 218/PE14</b>	Para Poliamida de 14 mm
<b>UC 218/PE16</b>	Para Poliamida de 16 mm
<b>UC 218/PE1/4</b>	Para Poliamida de 1/4"
<b>UC 218/PE3/8</b>	Para Poliamida de 3/8"
<b>UC 218/PE1/2</b>	Para Poliamida de 1/2"
<b>UC 218/PE5/16</b>	Para Poliamida de 5/16"



Union Conectora para Poliamida  
(TEE - Tubo - Tubo) Modelo PE

**VS**

<b>UC 218/PU06</b>	Para Poliamida de 6 mm
<b>UC 218/PU08</b>	Para Poliamida de 8 mm
<b>UC 218/PU10</b>	Para Poliamida de 10 mm
<b>UC 218/PU12</b>	Para Poliamida de 12 mm
<b>UC 218/PU14</b>	Para Poliamida de 14 mm
<b>UC 218/PU16</b>	Para Poliamida de 16 mm
<b>UC 218/PU1/4</b>	Para Poliamida de 1/4"
<b>UC 218/PU3/8</b>	Para Poliamida de 3/8"
<b>UC 218/PU1/2</b>	Para Poliamida de 1/2"
<b>UC 218/PU5/16</b>	Para Poliamida de 5/16"



Union Conectora para Poliamida  
(Tubo - Tubo) Modelo PU

**VS**

REPUESTOS

SCANIA

- UC 218/PV04** Para Poliamida de 4 mm
- UC 218/PV06** Para Poliamida de 6 mm
- UC 218/PV08** Para Poliamida de 8 mm
- UC 218/PV10** Para Poliamida de 10 mm
- UC 218/PV12** Para Poliamida de 12 mm
- UC 218/PV1/4** Para Poliamida de 1/4"
- UC 218/PV3/8** Para Poliamida de 3/8"
- UC 218/PV1/2** Para Poliamida de 1/2"
- UC 218/PV5/16** Para Poliamida de 5/16"



Union Conectora para Poliamida (Tubo - 90°) Modelo Pv

**VS**

REPUESTOS

SCANIA

**VAL 221/15**

14 x 1.5  
Presión 1.5kg



**Bosch**  
1 457 413 013

Válvula de sobrepresión

**SCANIA VABIS/111/112**

**VAL 221/15A**

14 x 1.5  
Presión 2kg



**Iveco**  
500328251  
**Bosch**  
1457413013

Válvula de sobrepresión

**SCANIA VABIS/111/112**

**VAL 221/15B**

14 x 1.5  
Presión 1kg



Válvula de sobrepresión

**SCANIA 111/112**

**VAL 221/16**

14 x 1.5



Válvula para bomba P

**FIAT 619 N**

**VAL 221/17**

14 x 1.5



**Bosch**  
1 417 413 047

Válvula

**MERCEDES BENZ 1114**

**VAL 221/19A**

10 mm



Válvula anti-retorno de entrada y salida recta

**VS**

**VAL 221/23**

14 x 1.5



**Bosch**  
1 417 413 082

Válvula

**SCANIA 124**

**VAL 221/31**



**Scania**  
1379215  
1864034  
**Bosch**  
2 417 413 092

Válvula

**SCANIA 420**

REPUESTOS

**VAL 222/1**



**Bosch**  
2 443 123 021  
**Fiat**  
763 178

Para bomba alimentadora tipo Bosch (todas) Color Roja

VS

**VAL 222/2**



**Bosch**  
2 443 203 001  
1 414 027 300  
**Iveco**  
773 987  
**Lucas/Delphi**  
7027-121

Para bomba alimentadora tipo Bosch (todas) Color Blanca

VS

**VAL 222/3**

Ø19mm



**Lucas/Delphi**  
7092-256A  
-  
**AC 559 3866**

Para bomba alimentadora (todas)

**SCANIA**

**VAL 222/4**

Ø18mm



**Bosch**  
2 447 419 002  
2 447 419 002

Para bomba alimentadora Bosch tipo M

**SCANIA**

REPUESTOS

**VAS 225/1**



Vaso de plástico para prefiltro Bosch

**SCANIA**

**VAS 225/12**



Vaso de plástico especial para prefiltro tipo Bosch

VS

**VAS 225/19C**



**Racor**  
KR-27004  
**Mercedes Benz**  
3760927104  
**Scania**  
524014

Vaso decantador de plástico para filtro Racor

**SCANIA**

**VAS 225/20B**



**Racor**  
900FG  
1000FG

Vaso decantador de plástico para filtro Racor y trampa de 1000 para FC 151/50B

**SCANIA**

**VAS 225/21L**



**Bosch**  
2 459 999 002

Vaso de vidrio para prefiltro tipo Bosch liso

VS

**VAS 225/41**

Rosca P/Purgador  
M21 x 1,25 - 6H



**Scania**  
524 014  
**M. Benz**  
376 092 7104  
**Racor**  
KR 27004

Vaso de aluminio decantador para conjunto filtro tipo Racor

**SCANIA**

**VAS 225/41C**

Rosca P/Purgador  
M21 x 1,25 - 6H



**Scania**  
524 014  
**M. Benz**  
376 092 7104  
**Racor**  
KR 27004

Contiene: Vaso decantador, o ring y purgador  
Vaso de aluminio decantador para conjunto filtro tipo Racor

**SCANIA**

### TOBERAS

tmDLA142P221	0433171180	Scania PO 3 HL / HR - PO3 / 210 / 250 / 230 / 0 430 133 992 KBEL 97 P 10
tmDLA146P154	0433171165	Scania 112 Intercooler (BOMBA 7126) / 0 430 133 992 KBEL 97 P 10
tmDLA147P538	0433171398	Scania 265 motor DSC 12.02 / 0 430 133 948 KBEL 100 P 62
tmDLA150S853	0433271829	Saab Scania L-112.(c/turbo) - 0 431 214 997 KBAL 109 S 6/13
tmDLA155P230	0433171188	Scania 113 Intercooler / 0 430 133 989 KBEL 97 P 13
tmDLA155P306	0433171221	Scania P 113 / 400 - R 113 / 0 430 133 989 KBEL 97 P 13



### ELEMENTOS

em2418450067	2418450067	Saab Scania DS-11 Tucumano turbo
em2418455129	2418455129	Saab Scania L-112
em2418455134	2418455134	Scania Intercooler Mercedes Benz LS 1633 - LS 1938
em2418455165	2418455165	Scania L-113 / LC 250
em2418455518	2418455518	Scania P / R / T 124 C / G / L motor DSC 12-02 (Euro II) N° de bomba 0402946014
em2418455542	2418455542	Scania PR 94 / 310 / T94 / 310 / L94
em2418455548	2418455548	Scania P/R/Rt 114 - T/R 114



### VÁLVULAS

vm2418554033	2418554033	Saab Scania DS-11tucumano turbo use 2 418 554 015 / 017
vm2418554045	2418554045	Scania 112 sin turbo
vm2418554047	2418554047	Saab Scania L 112 con turbo
vm2418554065	2418554065	Scania 112 Intercooler
vm2418554069	2418554069	Scania Argentina 113
vm2418554077	2418554077	Scania K113 Omnibus



ssS1881260



Scania  
1881260  
1393113  
1452862  
1488340

Sensor de presión de aceite DMB

SCANIA SERIE 3 DSC12 / SERIE 4 DC12

ssS395641



Scania  
395641  
264816  
Volvo  
4880804

Sensor de velocidad DMB

SCANIA P94/R113/T113/F114/P114/R114/T114/K114  
P124/R124/T124/K124/R143/T143/R164

REPUESTOS

**cm1122-576**



Injectores  
0414701008 0414701057  
04147010019 0414701067  
0414701045

**Bosch**  
0433171576  
**Scania**  
1412401

Tobera Common rail - DLLA150P848

SCANIA 114 340-381 1995 MOTOR 10,6D DC11,03 DC11,04  
124 360-420 1995 MOTOR 12,0D DC12,02 K IB BUS EURO 3 P360 T400 T420  
164 480 2000-2004 MOTOR DC16,01 DC16,02 R480 T480 EURO3

**cm1522-2320**



**Scania**  
P2872320

Tobera para inyector 2872544 Cummins XPI

**SCANIA D9 - D13**

**cm1522-2321**



**Scania**  
P2872321

Tobera para inyectores 2031835/2086663 Cummins XPI

**SCANIA D9 - D13**

**cm1522-4025**



**Scania**  
P4384025

Tobera para inyectores 2488244 Cummins XPI

**SCANIA D9 - D13**

**cm1522-4708**



**Scania**  
P4954708

Tobera para inyectores 2872405 Cummins XPI

**SCANIA D9 - D13**

**cm1522-7551**



**Scania**  
P2897551

Tobera para inyectores 2057401 Cummins XPI

**SCANIA D9 - D13**

REPUESTOS

**cm1520-1835**



**Scania**  
2031835  
2086663  
1881564

Inyector DMB Cummins XPI

**SCANIA D9 - D13**

**cm1520-2284**



**Scania**  
2872284  
2872289  
4955080

Inyector DMB Cummins XPI

**SCANIA D9 - D13**

**cm1520-2544**



**Scania**  
2872544

Inyector Cummins XPI

**SCANIA D9 - D13**

**cm1520-2544A**



**Scania**  
2872544

Inyector original Cummins XPI

**SCANIA D9 - D13**

**cm1520-7401**



**Scania**  
2057401

Inyector DMB Cummins XPI

**SCANIA D9 - D13**

**cm1520-7401A**



**Scania**  
2057401

Inyector DMB Cummins XPI

**SCANIA D9 - D13**

**cm1520-8244**



**Scania**  
2488244

Inyector DMB Cummins XPI

**SCANIA D9 - D13**

REPUESTOS

cm1525-4811



Scania  
5314811

Válvula DMB para inyector Cummins XPI  
**SCANIA D9 - D13**

REPUESTOS

cm2171-006



Kit de o-rings externo

**SCANIA - BOSCH**

cm2171-008



Kit de o-rings externo

**SCANIA - BOSCH**

Scania  
1440576  
Iveco  
500379769  
Bosch  
F00VX99995

cm2171-012



Kit de o-rings para solenoides

**SCANIA - BOSCH**

cm2171-018

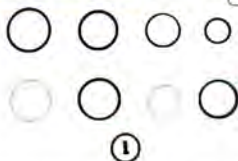

Kit de o-rings para inyector mas solenoide

**SCANIA**

cm2171-020

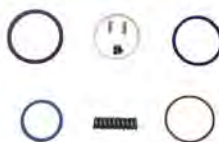

Kit para Scania

**SCANIA - BOSCH PDE90/PDE100**

Bosch  
F00HN37912  
Scania  
1541175

REPUESTOS

AC 115/505



Cummins  
4307148

Arandela para inyector HPI  
**SCANIA DC12/DT12 - VOLVO - NAVISTAR  
CUMMINS ISX/QSX**

AC 115/506



Arandela de cobre externa de asiento de inyector XPI  
**SCANIA R450/R550 - DC09/DC13/DC16 - P/G/R/T  
CUMMINS ISX15**

E 146/101



Espiga para inyector HPI  
**SCANIA DC12/DT12 - VOLVO - NAVISTAR  
CUMMINS ISX/QSX**

FM 152/101



Scania  
1421174  
ED3087316  
Cummins  
3348004

Filtro blanco DMB para inyector HPI  
**SCANIA DC12/DT12 - VOLVO - NAVISTAR  
CUMMINS ISX/QSX**

FM 152/102



Scania  
1434707  
Cummins  
4006962

Filtro negro DMB para inyector HPI  
**SCANIA DC12/DT12 - VOLVO - NAVISTAR  
CUMMINS ISX/QSX**

REL 185/101



Scania  
1801481

Retén para inyector HPI  
**SCANIA DC12/DT12 - VOLVO - NAVISTAR  
CUMMINS ISX/QSX**

REPUESTOS

cm2571-1237



Scania  
1441237

Kit de reparación DMB para inyector HPI  
SCANIA DC12/DT12 - VOLVO - NAVISTAR  
CUMMINS ISX/QSX

cm2571-1240



Kit espiga y retén para inyector HPI  
SCANIA DC12/DT12 - VOLVO - NAVISTAR  
CUMMINS ISX/QSX

cm1521-2820



Scania  
1932820  
1933246  
1889112  
1794862

Kit de reparación externa DMB para inyector XPI ISX  
SCANIA R450/R550 - DC09/DC13/DC16 - P/G/R/T  
CUMMINS ISX15

cm2571-1245



FM 152/101

Cód. Originales  
Scania  
1421174  
ED3087316  
Cummins  
3348004



FM 152/102

Cód. Originales  
Scania  
1434707  
Cummins  
4006962



cm2571-1237

Código original kit Scania  
1441237

Cód. Originales  
Cummins  
1- 3867654 (Negro)  
2- 4010577 (Verde)  
3- 4307148 (Arandela)  
4- 3347939 (Amarillo)  
5- 3347937 (Violeta)



cm2571-1240

Kit completo o'rings, arandela, espiga, retén y filtros para inyector ISX/QSX sistema HPI

SCANIA DC12/DT12 - VOLVO - NAVISTAR

REPUESTOS

tg6750-3B



Scania  
1371788  
1503113 VKM  
1493670 VKM CV 56001  
1545982  
1459988

Tensor

SCANIA 114 DSC/DC 11/124 DC12/DT12/144 DSC14  
BUS K/L/N 94 DC9/BUS K 114/K 124 DC11/DC12

tg6750-10B



Plano  
96 x 32 x 10  
Scania  
1514086  
1353717  
1428940  
VKM  
CV 56002

Tensor

SCANIA 114 DC11/DSC11/124 DC12/144 DSC14  
BUS K/L/N 94, K114, K124

tg6750-41B



Scania  
1514087  
1413609  
1428941  
VKM  
VKM CV 56003

Tensor

SCANIA 114 DC11, 124 DC12, BUS K/L/N94

tg6750-41B



Scania  
1514087  
1413609  
1428941  
VKM  
VKM CV 56003

Tensor

SCANIA 114 DC11, 124 DC12, BUS K/L/N94

tg6750-42B



Scania  
1512749  
1795775  
1858885  
VKM  
VKM CV 56007

Tensor

SCANIA 4/P/G/R/T SERIES (D9/D11/D12/D13  
DC9/DC11) BUS 4/F/K/N SERIES (DC9)

tg6750-47B



Scania DAYCO  
1858884 APV1119  
1510698 FEBI  
1795774 23296  
SKF INA  
VKM CV 56008 532045210

Tensor

SCANIA 4/P/G/R T SERIES  
BUS 4/F/K/N SERIES DC9

tg6750-56B



Scania  
1779757 SKF  
1870553 VKM CV 56011  
2192038 APV2729  
2197391

Tensor

SCANIA SERIE 5 PGR D13

tg6750-58B



Plano  
74 x 32

Scania  
1859654/R

Polea reparación

SCANIA SERIE 4 114 C/340-380 - SERIE 4 124 C/360-400  
SERIE P P380/470 - SERIE R R/340 R/380 - SERIE G G/420

tg6750-59B



Scania  
1860734  
2089431  
2129402  
SKF  
VKM CV 56012

Rueda tensora

SCANIA P/G/R/T 9.0 - 16.4 09.07

tg6750-62B

REPUESTOS



Scania  
1512181  
1774654  
1859657  
1774650  
Dayco  
APV1120

INA

534009220

Tensor

SCANIA K 124 SERIE 5 P.G.R  
MOTOR DC9 / DC12 / DC11 / DT12

REPUESTOS

MTI 5507

Ø89x140



4 CAPAS  
2 ANILLOS  
Scania  
525050, 488368  
390581, 1736053  
1851981

Fuelle Intercooler

SCANIA T/R/K112/113/142

MTI 5508

Ø66x75



4 CAPAS

Scania  
375527  
1347080

Manguera Admisión Turbo

SCANIA T/R112/113/142

MTI 5510

Ø89x140

C/FLÚOR



4 CAPAS  
2 ANILLOS

Scania  
488368

Fuelle Intercooler

SCANIA T/R/K 112/113

MTI 5531

Ø45/55x70

SILICONA



4 CAPAS

Scania  
241805

Reducción Radiador Inferior

SCANIA

MTI 5538

Ø15x105/55

SILICONA



4 CAPAS

Scania  
267460  
34821428

Caño refrigeración Tapa Compresor

SCANIA

MTI 5539

Ø30x383



4 CAPAS

Scania  
2701142

Fuelle radiador superior

SCANIA BR116-K112

MTI 5540M

4 CAPAS



Scania  
382983

Manguera de radiador inferior

SCANIA 113

MTI 5542

Ø55x290

4 CAPAS



Scania  
290849

Fuelle radiador inferior

SCANIA TRK112-113

MTI 5543M

4 CAPAS



Scania  
382985

Manguera de admision de aire, carcasa de termostato

SCANIA 113

MTI 5557

Ø55x200x90

1 CAPA



Scania  
318364

Caño curvo inf. a termostato

SCANIA TR112

MTI 5590

Ø21.5x91.5

4 CAPAS



Scania  
397999  
1376875

Conexión Turbo Aceite

SCANIA 112/113

MTI 5592

Ø80/100x170

4 CAPAS

4 ANILLOS

Scania

1525145, 1442579  
1442567, 1358202  
1522011, 1522010  
1794725, 1809771

Fuelle Turbo

SCANIA 114 - SERIE 4

MTI 5593

C/FLÚOR

Ø80/100x170

4 CAPAS  
4 ANILLOS



Scania  
1525145, 1442579  
1442567, 1358202  
1522011, 1522010  
1794725, 1809771

Fuelle Turbo

SCANIA 114 - SERIE 4

MTI 5598

C/FLÚOR

Ø21x80

4 CAPAS



Scania  
1433110

Conexion Turbo Aceite

SCANIA 113

REPUESTOS

dmT-4L-A

**4LGZ  
TV61**

**Referencias**

<b>Garret</b>	465990-0007	<b>Borgwarner</b>	185576
<b>Scania</b>	14009880000	<b>Holset</b>	
	250248		3525150
	252320		305720
	305720		3525151
	510545		
	520320		
	307371		
	537408		
	375500		
	543063		



SCANIA - DS11 - K111

dmT-GT42-A

**GT4288  
S400207  
HX50**

**Referencias**

<b>Garret</b>	703072-0003
	703072-0004
	452109-0010
<b>Scania</b>	
	1485645
	1485646
<b>Holset</b>	
	3597654
	3597655
	3597656
<b>Borgwarner</b>	
	3591777



SCANIA 124 - DSC12-01

dmT-TA45-A

**TA4516  
GT4288  
S400201  
HX50**

**Referencias**

<b>Garret</b>	466950-0004
<b>Scania</b>	
	1489194
	1324420
	54005201
<b>Borgwarner</b>	
	313063
	174618
<b>Holset</b>	
	3525517
	3537639
	3528650
	3528651



DSC11-17 / 113-360  
DSC11-17 / 112 - DSC11-17 / 114

dmT-TO4E06-A

**TO4E06**

**Referencias**

<b>Garret</b>	466616-0011
<b>Scania</b>	
	1317654
	1317660
	1317662
	1351127
	1362027



SCANIA P93 MOTOR DSC9 6 CIL

dmT-TA45-B

**TA4536**

**Referencias**

<b>Garret</b>	465213-0001
<b>Scania</b>	
	1670970
	1671731
<b>Schwitzer</b>	
	170404
<b>Holset</b>	
	3528018



113-310 DS11-34

dmT-GT42-C

**GT4288**

**Referencias**

<b>Garret</b>	452109-0002	<b>Holset</b>	3591775
	709574-0004		3591776
<b>Scania</b>			3590421
	1485648		3590423
	1485646		3591777
	1485645	<b>Schwitzer</b>	
	1423038		174619
	1423037		
	1423036		
	1399269		
	1388059		



124 DSC12

dmT-HX55-C

**HX55**

**Referencias**

<b>Garret</b>	807067-0002
<b>Scania</b>	
	1423041
	1538372
<b>Holset</b>	
	4038613
	3594236
	3594238
	3594239
	4038616
	4038617
	4031122
	4031341
	3597728



SCANIA K/P/R/T 124 / K/G/P/R/T 114/380/420  
DC12 EURO 3

REPUESTOS

**bcS1314653**

Scania  
1314653 571689  
10575689 575159  
1575159 10575159  
1571689 10571689

Bomba levanta cabina DMB

**SCANIA SERIE 2/SERIE 3****bcS1378531**

Scania  
1378531  
383524  
575152  
575154

Bomba levanta cabina DMB

**SCANIA SERIE 2/SERIE 3****bcS1549740**

Scania  
1549740  
1375497  
1349010

Bomba levanta cabina DMB

**SCANIA S4 114/S4 124 R****bcS1794907**

Scania  
1549740  
1375497  
1349010

Bomba levanta cabina DMB

SCANIA P SERIE 14L/16L/19L/49H - G SERIE 14L/16L/19L/19H  
R SERIE 16L/19N/19H/19T

**bcW2R2899501A**

Scania  
1118103  
1378524  
1378526  
1575155

Bomba levanta cabina DMB

**SCANIA 113**

REPUESTOS

**fcS1526571**

Scania  
1526571  
1371207  
1851212  
2142433

Flexible levanta cabina DMB

**SCANIA SERIE 4/SERIE P,G,R,T****fcS1526572**

Scania  
1526572  
1371208  
1851213  
2142423

Flexible levanta cabina DMB

**SCANIA SERIE 4****fcS1526573**

Scania  
1526573  
1426339  
2142425  
526573

Flexible levanta cabina DMB

**SCANIA SERIE 4****fcS2142410**

Scania  
2142410  
1767480  
1851249

Flexible levanta cabina DMB

SCANIA SERIE P,G,R,T/SERIE 3 BUS  
SERIE 5/EURO 5/6



# SCANIA

LÍNEA PESADA

## Catálogo de tuberías



- Tuberías flexibles y rígidas.
- Lubricación de turbo y descarga.
- Lubricación de aceite.
- Tuberías de inyección convencional y Common Rail.
- Tuberías de inyección para bancos de prueba convencional y Common Rail.
- Tuberías flexibles y rígidas para compresor.
- Tuberías de freno y dirección hidráulica.
- Tuberías de agua.

### ATENCIÓN

Sobre presentación de muestra fabricamos todo tipo de tuberías para el automotor.

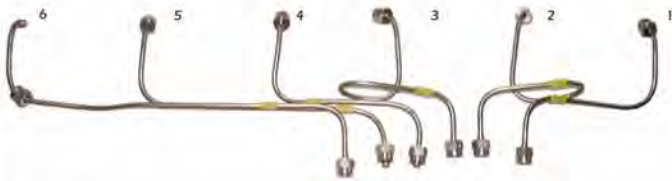

**NLS 2**

Conjunto de 6 tuberías de inyección

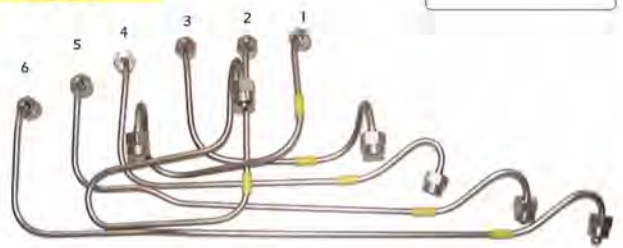
**SCANIA B-71/L-71**
**NLS 3**

Conjunto de 6 tuberías de inyección

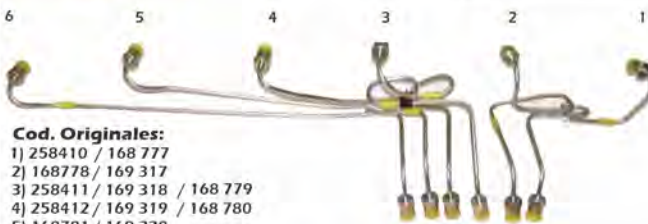
**SCANIA B-75/L-75**
**NLS 4**

**Cod. Originales:**

- 1) 258410 / 168 777
- 2) 168778 / 169 317
- 3) 258411 / 169 318 / 168 779
- 4) 258412 / 169 319 / 168 780
- 5) 168781 / 169 320
- 6) 168782 / 169 321

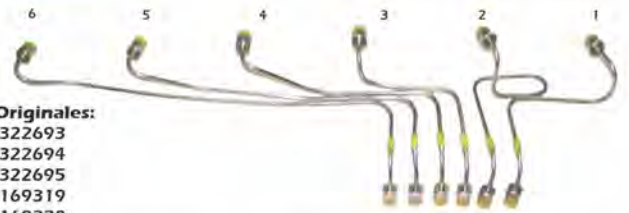
Conjunto de 6 tuberías de inyección

**SCANIA 111 L/LS/LT 110/TURBO  
MOTOR D11/DS11/D11 TURBO**
**NLS 5**

**Cod. Originales:**

- 1) 322693
- 2) 322694
- 3) 322695
- 4) 169319
- 5) 169320
- 6) 169321

Conjunto de 6 tuberías de inyección

**SCANIA 111 SIN TURBO MOTOR D11**
**S 6**
**Motor: DS 11**
**S 6 JA**
**Motor: DS 11 (Juego armado)**
**S 6 - A JA**
**1er Tramo (1 - 2 - 3)**
**S 6 - B JA**
**2do Tramo (4 - 5 - 6)**
**Cod. Original:**

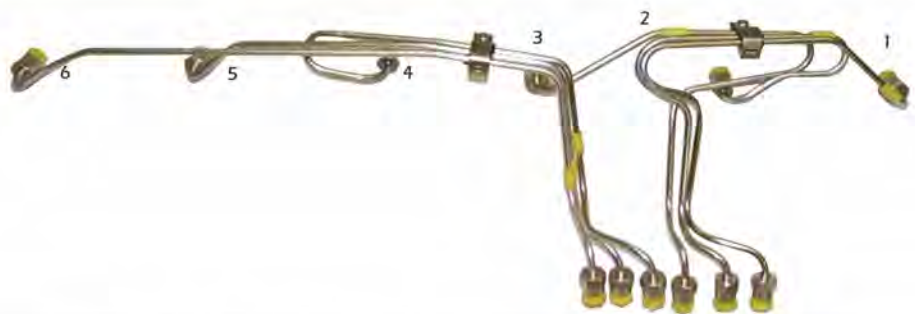
- |            |   |                      |
|------------|---|----------------------|
| 1) 312 217 | } | 1er. tramo (289 898) |
| 2) 312 218 |   |                      |
| 3) 312 219 |   |                      |
| 4) 312 221 | } | 2do. tramo (289 899) |
| 5) 312 222 |   |                      |
| 6) 312 223 |   |                      |



Conjunto de 6 tuberías de inyección

**SCANIA 112 T/R/M/H/HS/E/ES**
**S 7**
**Motor: DS 11**
**S 7 JA**
**Motor: DS 11 (Juego armado)**
**S 7 - A JA**
**1er Tramo (1 - 2 - 3)**
**S 7 - B JA**
**2do Tramo (4 - 5 - 6)**
**Cod. Original:**

- |            |   |                     |
|------------|---|---------------------|
| 1) 365 485 | } | 1er. tramo (365484) |
| 2) 365 486 |   |                     |
| 3) 365 487 |   |                     |
| 4) 365 489 | } | 2do. tramo (365488) |
| 5) 365 490 |   |                     |
| 6) 365 491 |   |                     |



Conjunto de 6 tuberías de inyección

**SCANIA VABIS H113 T/R/OMNIBUS K 113 TURBO**

### NLS 8

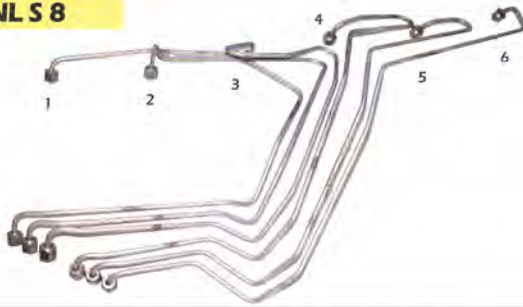

Conjunto de 6 tuberías de inyección

**SCANIA P-94**

### NLS 9



**Cod. Original:**  
 N°1) 137.5369  
 N°2) 137.5370  
 N°3) 137.5371  
 N°4) 137.5372  
 N°5) 137.5373  
 N°6) 137.5374

Conjunto de 6 tuberías de inyección

**SCANIA P124/K124 MOTOR DSC-12**

### NLS 10

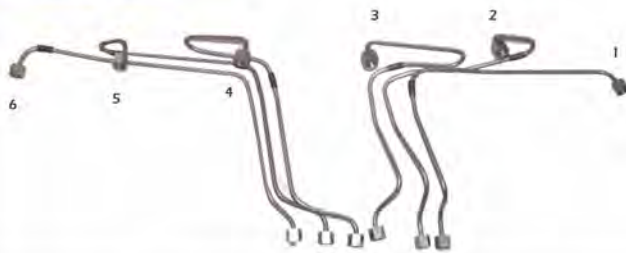

Conjunto de 6 tuberías de inyección

**SCANIA P-93**

### NLS 11



**Cód. Original**  
 N°1 y N°2 1391911  
 N°3 y N°4 1391914  
 N°5 y N°6 1391917  
 N°7 y N°8 1391920

Conjunto de 8 tuberías de inyección

**SCANIA V8 440HP TURBO MOTOR Ds14**

### NLS 12



**Scania**  
 N°1 1376785  
 N°2 1376786  
 N°3 1376787  
 N°4 1376788  
 N°5 1376789  
 N°6 1376790

Conjunto de 6 tuberías de inyección

**SCANIA 114 MOTOR 320/360 HP  
 DOBLE TAPA DE CILINDROS**

### MV 8451



Planchuela soporte para tubería de inyección S6JA

**SCANIA 112/DS11**

**MV 2002**Scania  
540611

Filtro a bomba de alimentación

**SCANIA 112****MV 2003**Scania  
289898

Rebase de inyector

**SCANIA 112****MV 2004**Scania  
289899

Rebase de inyectores

**SCANIA 112****MV 2009**Scania  
173908

Cañería de aspiración

**SCANIA 112****MV 2016**Scania  
249611

Retorno de combustible

**SCANIA L111/BR116****MV 2016-CT**

Retorno de combustible

**SCANIA L111/BR116****MV 2018**Scania  
249608

Alimentación de combustible

**SCANIA L111/BR116****MV 2038**Scania  
225846

Bomba inyectora a tanque

**SCANIA 111/112**

**MV 2046**Scania  
321464

Retorno de combustible

**SCANIA R/K/T 112****MV 2052**Scania  
313748

Flexible de gasoil

**SCANIA 112****MV 2055**Scania  
306242

Flexible de retorno de gasoil

**SCANIA 112****MV 2056**Scania  
313619

Caño rígido ojal a ojal

**SCANIA****MV 2057**Scania  
1110918

Retorno de inyectores

**SCANIA 112/113****MV 2072**Scania  
1673295

Bajada de retorno de inyectores

**SCANIA 113****MV 2076**

Limitador de humo K112/113 de bomba inyectora a admisión

**SCANIA****MV 2093**Scania  
2354575

Tubería flexible riel de combustible

**SCANIA L/P/G/R/S - SERIE**

**MV 0635A**

240 mm



Tubería universal de Manómetro

**VARIOS**

**MV 0635B**

1115 mm



Tubería universal de Manómetro

**VARIOS**

**MV 0635C**

800 mm



Tubería universal de Manómetro

**VARIOS**

**MV 0635D**

410 mm



Tubería universal de Manómetro

**VARIOS**

**MV 0635E**

630 mm



Tubería universal de Manómetro

**VARIOS**

**MV 0635F**

340 mm



Tubería universal de Manómetro

**VARIOS**

**MV 0635G**

200 mm



Tubería universal de Manómetro

**VARIOS**

**MV 2005A**



Scania  
239573

Reemplaza al  
MV 2005

Lubricación de balancines

**SCANIA L111/BR116**

**MV 2005B**

Lubricación de balancines. Con tuerca y virola

**SCANIA L111/BR116****MV 2006A**Scania  
306278

Engrase de grapodina de embrague

**SCANIA****MV 2006B**Scania  
Reforma  
306278

Engrase de grapodina de embrague

**SCANIA****MV 2006A-CT**

Engrase de grapodina de embrague

**SCANIA****MV 2006B-CT**

Engrase de grapodina de embrague

**SCANIA****MV 2012**Scania  
1108576

Lubricación de balancines

**SCANIA 113****MV 2019**Scania  
1673085

Lubricación de turbo

**SCANIA 113****MV 2020**Scania  
1672878

Retorno de aceite de turbo

**SCANIA 112/113**

**MV 2022**



Scania  
214552

Engrase de grapodina de embrague

**SCANIA 111**

**MV 2022CT**



Engrase de grapodina de embrague con tuercas

**SCANIA 111**

**MV 2023**



Scania  
242508

Rígido para varilla medición de aceite

**SCANIA 111**

**MV 2028**



Rígido para lubricación de turbo

**SCANIA**

**MV 2029**



Scania  
312839

Lubricación de turbo

**SCANIA 112**

**MV 2030**



Lubricación de turbo

**SCANIA**

**MV 2033**

Lubricación compresor L111 - BR116

Cod.Orig. 811 177

**MV 2037**

Flexible de lubricación

Cod.Orig. 811 178

**MV 2045**

Flexible de rebatimiento de cabina L112

Cod.Orig. 305 525

**MV 2047**

Flexible de rebatimiento de cabina - 112/113



**SCANIA**

**MV 2033CT**

Lubricación compresor L111 - BR116

**MV 2037CT**

Flexible de lubricación

**MV 2045CT**

Flexible de rebatimiento de cabina L112

**MV 2047CT**

Flexible de rebatimiento de cabina - 112/113

con tuerca



**SCANIA**

**MV 2050****Scania  
Reforma  
306278**

Lubricación de turbo

**SCANIA****MV 2051****Scania  
Reforma  
306278**

Rígido y flexible de aceite en teflón

**SCANIA****MV 2059**

Caño de aceite

**SCANIA 113****MV 2060****Scania  
167709**

Rígido para lubricación de turbo

**SCANIA****MV 2061****Scania  
232136**

Rígido lubricación bomba inyectora

**SCANIA 111****MV 2067****Scania  
1530826**

Retorno de aceite al turbo

**SCANIA SERIE 4 124****MV 2067A****Scania  
1471951  
1445502  
1433108**

Tubería rígida corta, descarga de aceite del turbo

**SCANIA SERIE 4 124****MV 2067KIT****Scania  
1422385  
1352984**

Kit descarga de aceite del turbo

**SCANIA SERIE 4**

**MV 2068**Scania  
1477190

Lubricación de turbo

**SCANIA 124 330HP****MV 2069**Scania  
1672871

Lubricación/Filtro a carter corto

**SCANIA 112/113****MV 2070**Scania  
312838

Lubricación compresor

**SCANIA 112/113****MV 2071**Scania  
1678336

Lubricación compresor

**SCANIA 112/113****MV 2008**Scania  
417888

Estabilizador de dirección, entrada a caja

**SCANIA 113****MV 2011**Scania  
814354

Tubería flexible de compresor. Largo 720mm

**SCANIA 112/113**

**MV 2013**

**MV 2021**



**Scania**  
147888 (2013)  
300957 (2021)

Lubricación compresor

**SCANIA 111**

**MV 2017**



**Scania**  
814815

Tubería flexible de freno. Largo 760mm

**SCANIA 112/113**

**MV 2017A**



**Scania**  
815152

Tubería flexible de freno. Largo 560mm

**SCANIA 112/113**

**MV 2017CT**



**Scania**  
814815

Tubería flexible de freno. Largo 760mm - Con tuercas

**SCANIA 112/113**

**MV 2024**



**Scania**  
811229

Tubería flexible de compresor

**SCANIA 111**

**MV 2024CT**



**Scania**  
13866375

Tubería flexible salida de compresor

**SCANIA 111**

**MV 2025**



**Scania**  
321538

Tubería flexible de freno

**SCANIA 111**

**MV 2025CT**



Tubería flexible de freno

**SCANIA 111**

**MV 2031****Scania**  
335345

Flexible de dirección hidráulica

**SCANIA 112****MV 2034****Scania**  
346077

Flexible de dirección hidráulica

**SCANIA R112/113****MV 2039****Scania**  
213213

Flexible de dirección hidráulica de depósito a bomba

**SCANIA 111****MV 2041**

Rígido dirección hidráulica

**SCANIA 112****MV 2042**

Flexible dirección hidráulica

**SCANIA****MV 2043****Scania**  
322567

Flexible dirección hidráulica

**SCANIA****MV 2044****Scania**  
153050

Flexible dirección hidráulica

**SCANIA L111/BR116****MV 2048**

Flexible dirección hidráulica

**SCANIA 112**

**MV 2058**Scania  
321538

Rigido de dirección hidráulica

**SCANIA****MV 2065**

Flexible de dirección hidráulica

**SCANIA****MV 2066**Scania  
13866375

Flexible de dirección hidráulica de depósito a bomba

**SCANIA 114****MV 2081**Scania  
1379469

Tubería flexible de dirección hidráulica

**SCANIA SERIE 4-94/114/124****MV 2293**Scania  
1680398

Tubería rígida circulación de agua con intercooler

**SCANIA 113****MV 2294**Scania  
334846

Tubería "Bastón" circulación de agua, depósito superior radiador

**SCANIA 112/113**

**MV 2026**

Tubería flexible de pulmón de rueda (largo)

**SCANIA****MV 2026CT**

Tubería flexible de pulmón de rueda (Largo) con tuerca

**SCANIA****MV 2027**

Tubería flexible de pulmón de rueda (Corto)

**SCANIA****MV 2027CT**

Tubería de pulmón de rueda (Corto) con tuerca

**SCANIA****MV 2032**Scania  
811172

Tubería flexible electroválvulas

**SCANIA L111****MV 2032CT**

Tubería flexible electroválvulas con tuerca

**SCANIA L111****MV 2035**Scania  
970914

Tubería flexible delantero

**SCANIA****MV 2036**Scania  
815446

Tubería flexible de freno delantero

**SCANIA**

**MV 2011**

720 mm.

Scania  
814354

Tubería flexible de compresor

**SCANIA 112/113****MV 2011A**

630 mm.

Scania  
814353

Tubería flexible de compresor

**SCANIA 112/113****MV 2011B**

560 mm.

Scania  
814351

Tubería flexible de compresor

**SCANIA 112/113****MV 2011C**

600 mm.

Scania  
814352

Tubería flexible de compresor

**SCANIA 112/113****MV 2011D**

500 mm.

Scania  
814350

Tubería flexible de compresor

**SCANIA 112/113****MV 2053**Scania  
305632

Rígido del compresor

**SCANIA****MV 2054**

Caño del compresor

**SCANIA****MV 2062**Scania  
305632

Serpentina del compresor

**SCANIA 113**

**MV 2063**



Serpentina del compresor

**SCANIA 113**

**MV 2064**



Serpentina del compresor

**SCANIA 113**

**MV 3561**



Salida del compresor

**SCANIA 112**

**MV 3574**



Salida compresor

**SCANIA 113**

Scania  
815462

**MV 3577**



Scania  
1521457  
1887055

Tubería flexible compresor

**SCANIA SERIE 4**

**MV 2010**



Cañería para agua

**SCANIA 112 / 113**

**MV 2049**



Cañería para agua

**SCANIA P93 / P94**

**MV 2090**



Scania  
1901729  
2145694

Tubería flexible refrigeración de purga de aire

**SCANIA SERIE 5 D13 PDE P/G/R/T MOTOR 12.0**

**MV 2091**



Scania  
1507014  
1483544  
106898

Tubería flexible refrigeración de agua de tapa - 6 cilindros

**SCANIA SERIE 5 D13 PDE P/G/R/T MOTOR 12.0  
P270/P310/P340/P380/P420/G340/G380/G420**

**MV 2092**



Scania  
1507013  
508495

Tubería flexible refrigeración de agua de tapa - 5 cilindros

**SCANIA SERIE 5 D13 PDE P/G/R/T MOTOR 12.0**

**MV 3562**



Freno neumático

**SCANIA 111/112**

**MV 3575**



Flexible freno

**SCANIA 113**

**EX 4**



Exhibidor para 4 tuberías

**VS**

**EX 5**



Exhibidor para 5 tuberías

**VS**

**EX 6**



Exhibidor para 6 tuberías

**VS**